

Tillykke med dit nye Villa helårstelt

Denne vejledning beskriver opstillingsprocessen. Studer vejledningen nøje før påbegyndelse af processen og vær opmærksom på din egen sikkerhed undervejs.

Gratulerer med ny villa helårstelt

Denne håndboken beskriver installasjonsprosessen. Studer bruksanvisningen nøye før du begynner prosessen og være klar over din egen sikkerhet underveis.

Congratulation with your new Villa all-year awning

This instruction describes the installation process. Carefully study the instruction before beginning the process and be aware of your own safety along the way.



Nødvendigt værktøj og antal personer
Nødvendig verktøy og antall personer
Necessary tools and number of persons

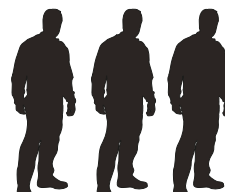

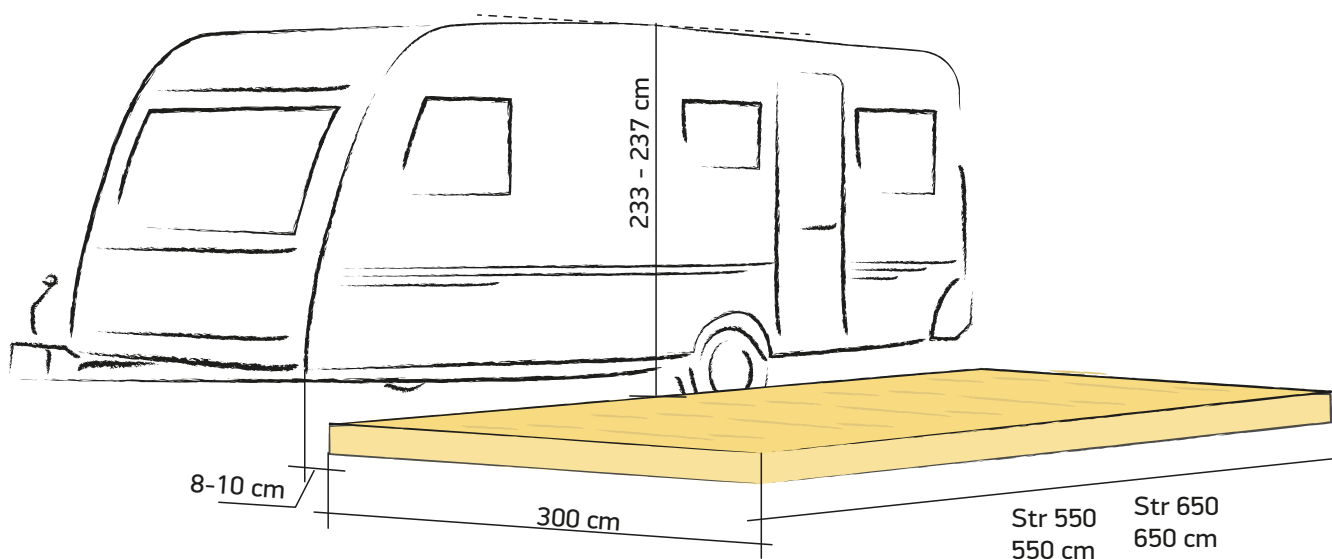

Påkrævede mål på trægulv
Påkrevd dimensjoner av tregulvet
Required measurements of wooden floor





Steldele • Rammedele • Frame parts

25 26 cm x 14 / x 16 26 27

24 30 cm x 4  

17 51 cm x 8



16 66 cm x 4 



15 67,5 cm x 4 



14 129 cm / 132 cm

12 132,5 cm x 4 

13 132,5 cm / 181 cm x 2

1 187 cm  

2 187 cm  



3 187 cm x 3 / x 4  

7 215,2 cm 



8 215,2 cm 

9 230,8 cm 



10 230,8 cm 

4 243,5 cm  

5 243,5 cm 

6 243,5 cm  



21 275 cm / 325 cm 

20 275 cm / 325 cm  

19 301,3 cm x 2 

18 301,3 cm x 12 / x 14

22 305 cm / 355 cm 

23 305 cm / 355 cm  

! Model 550 / Model 650

● Pack 1

● Pack 2

● Pack 3

28 

Stofdele • Stoff deler • Fabric parts

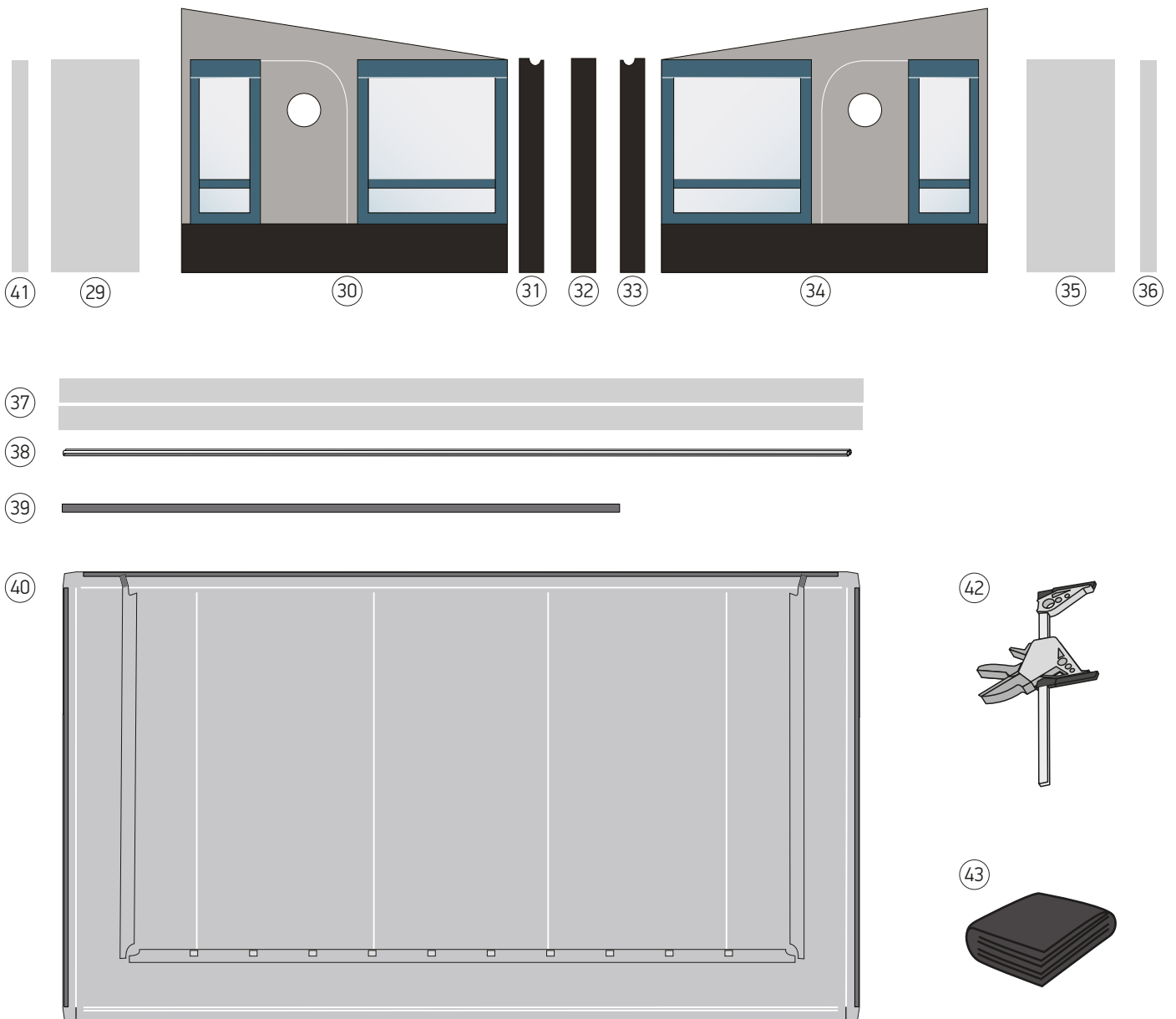

Beslag • Brakett • Brackets

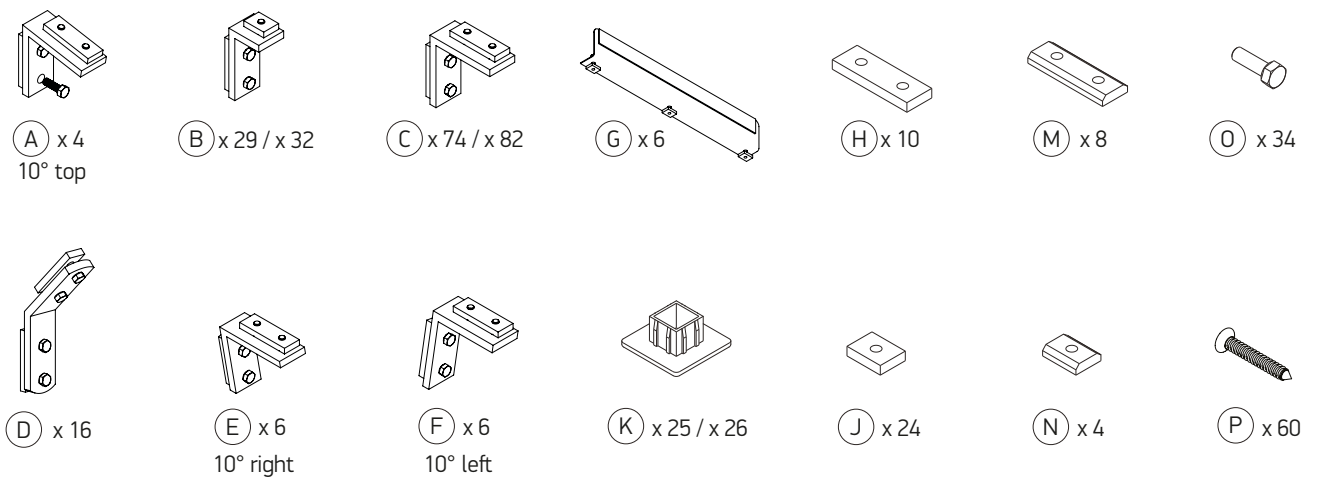

Valgfrie frontpaneler • Valgfrie frontpaneler • Optional front panels

Panel A

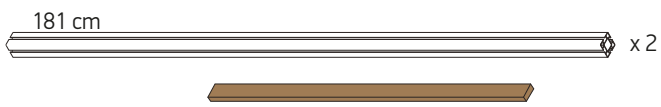
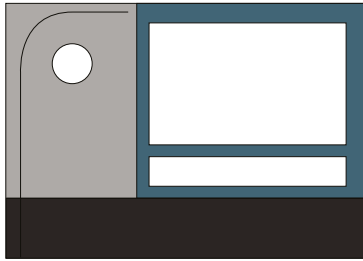

Panel D

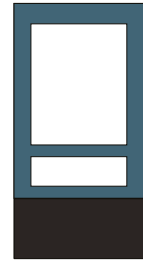

Panel B

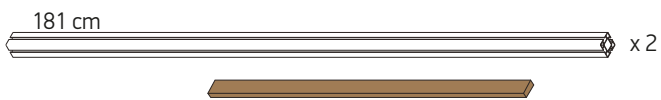
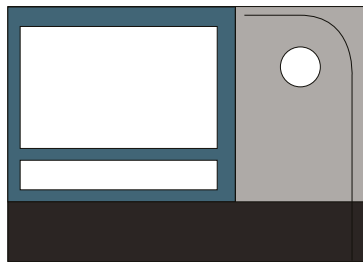

Panel E

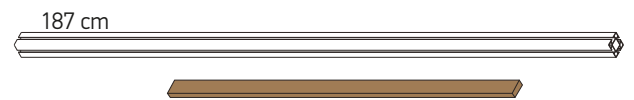
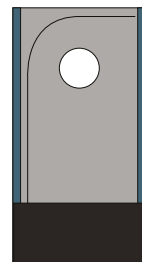

Panel C



Panel F

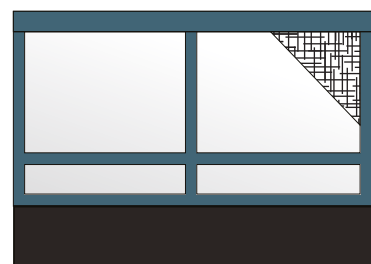

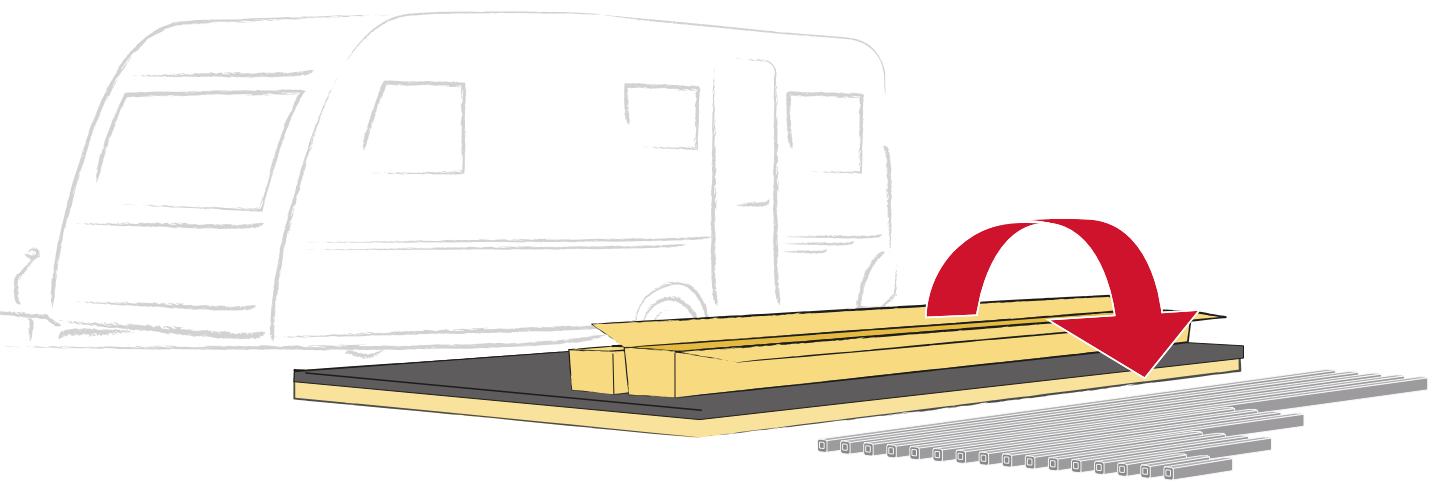
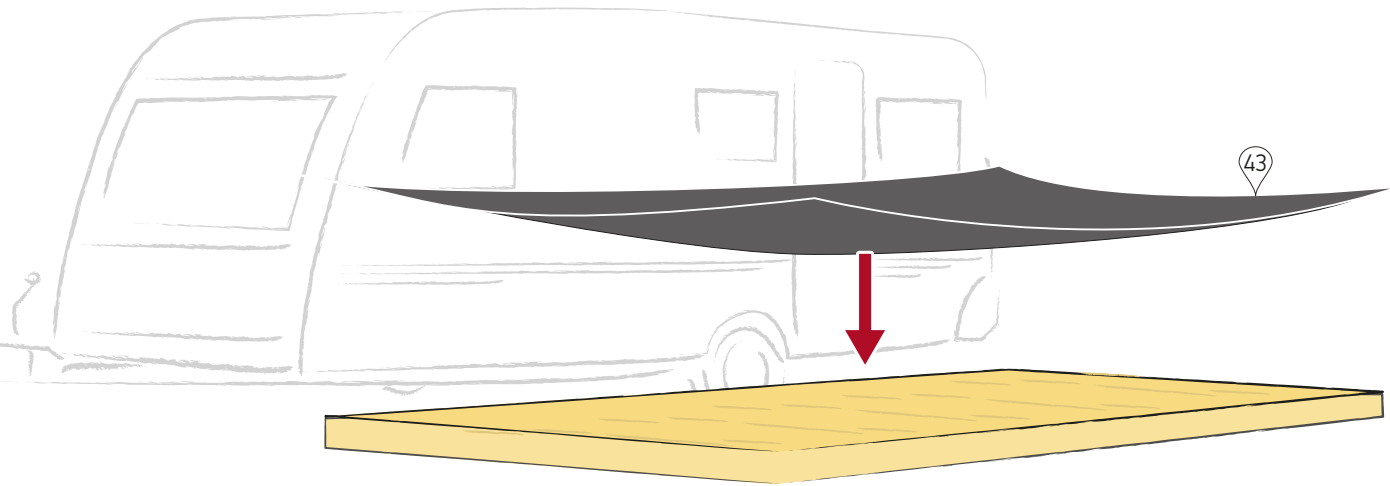

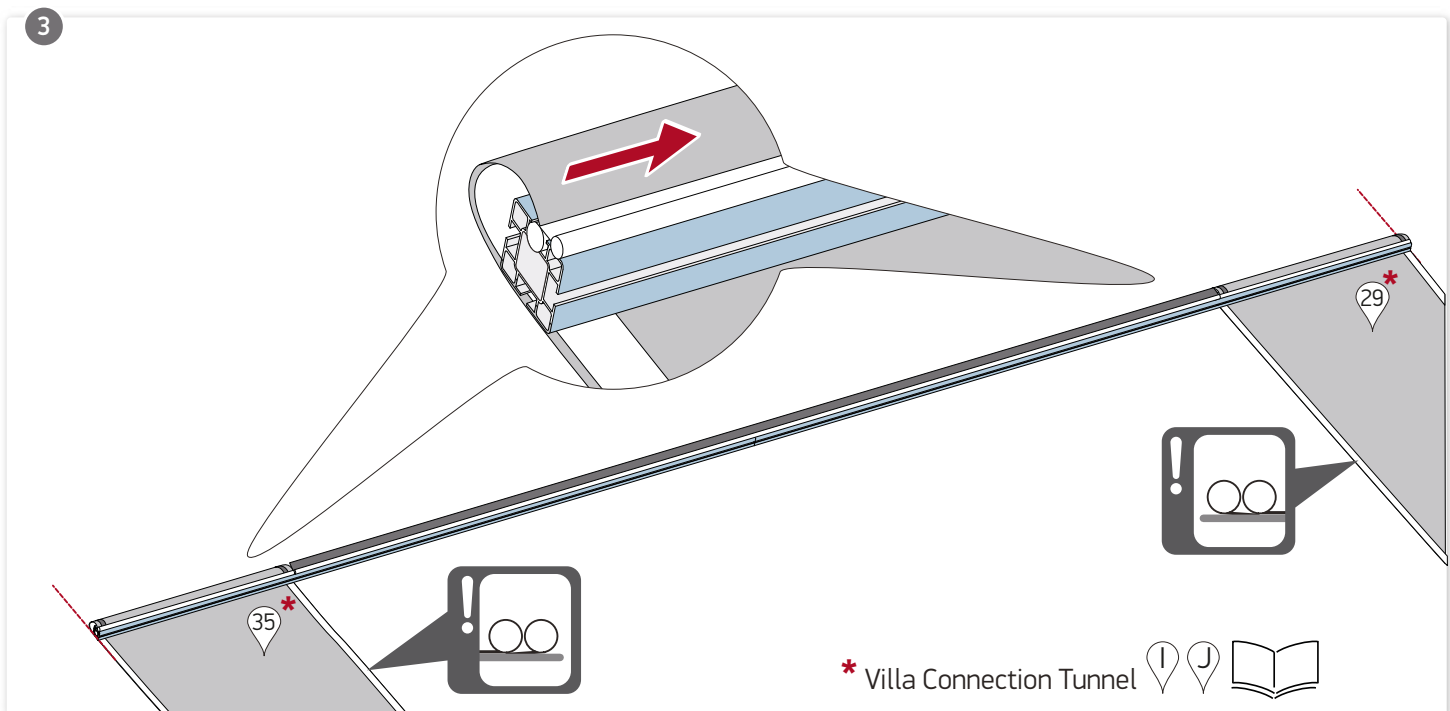
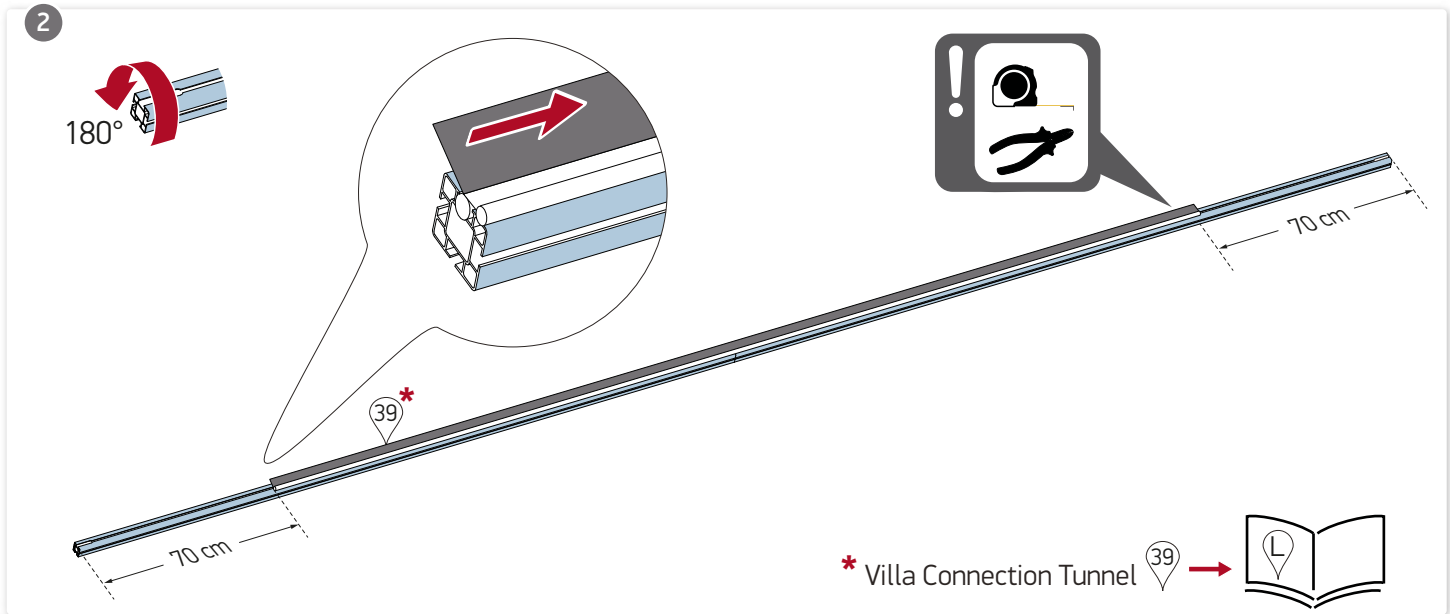
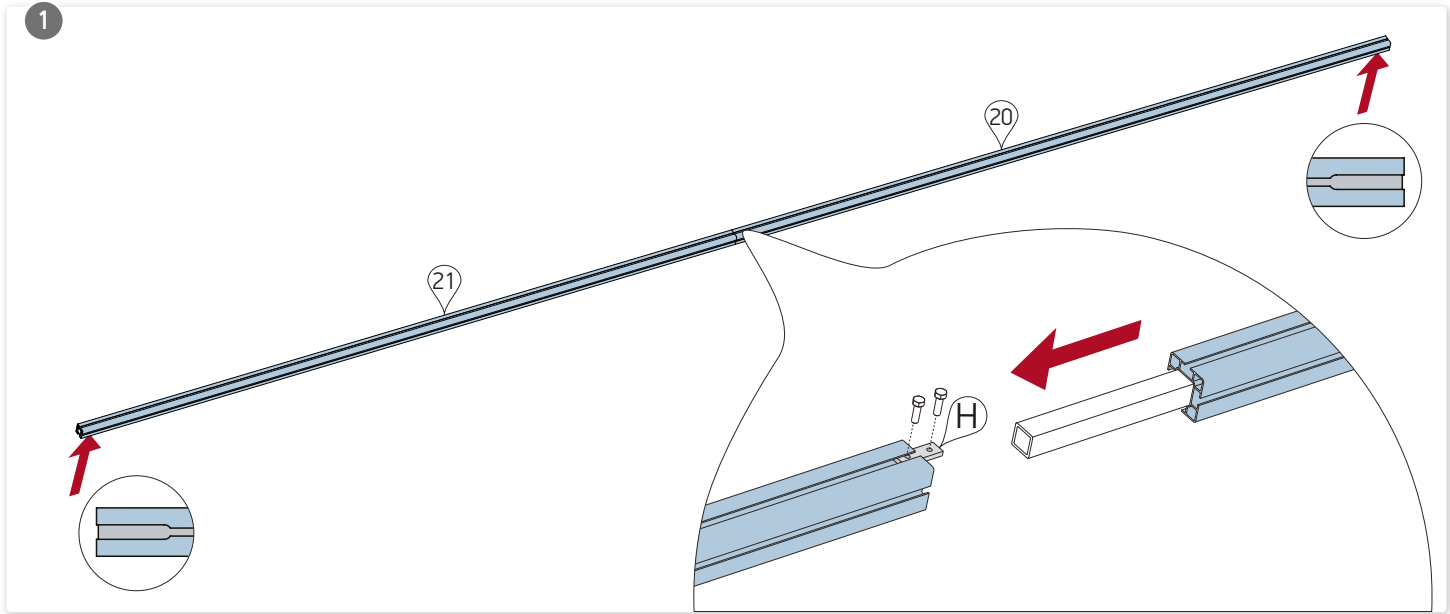

4

* Villa Connection Tunnel 

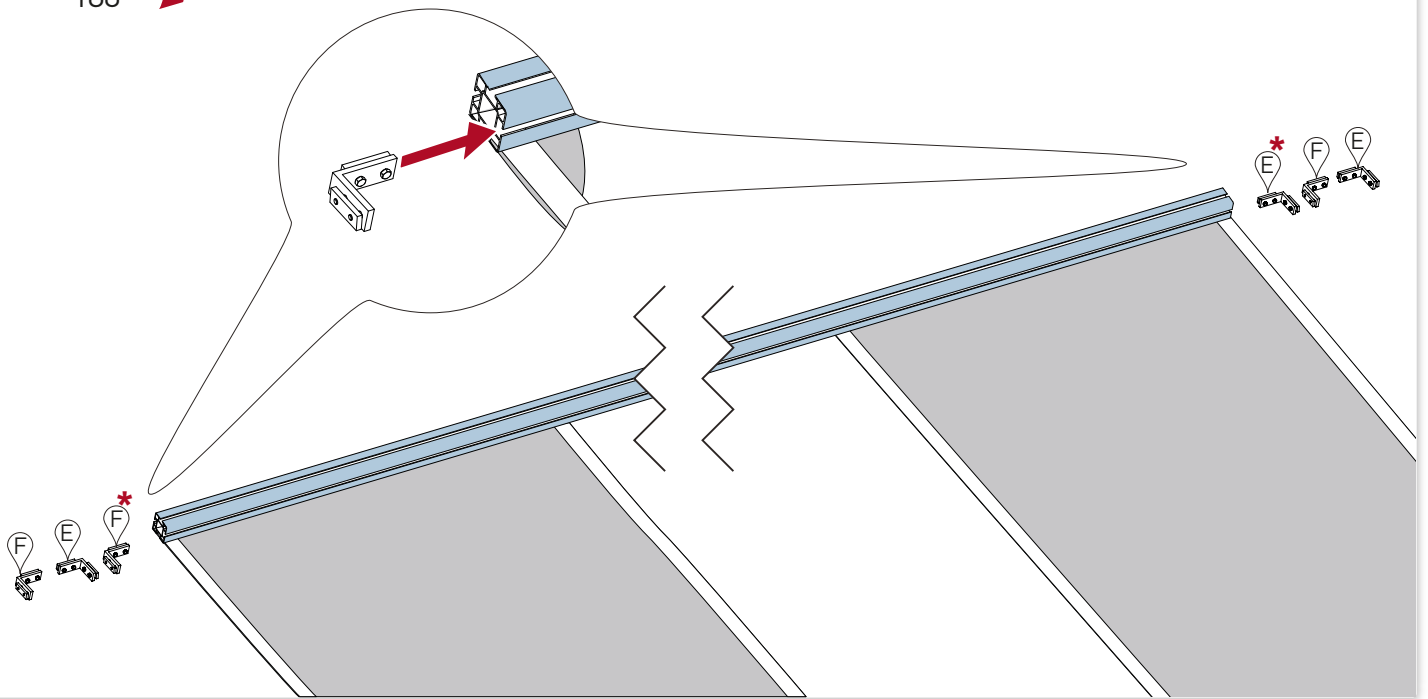
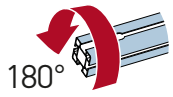

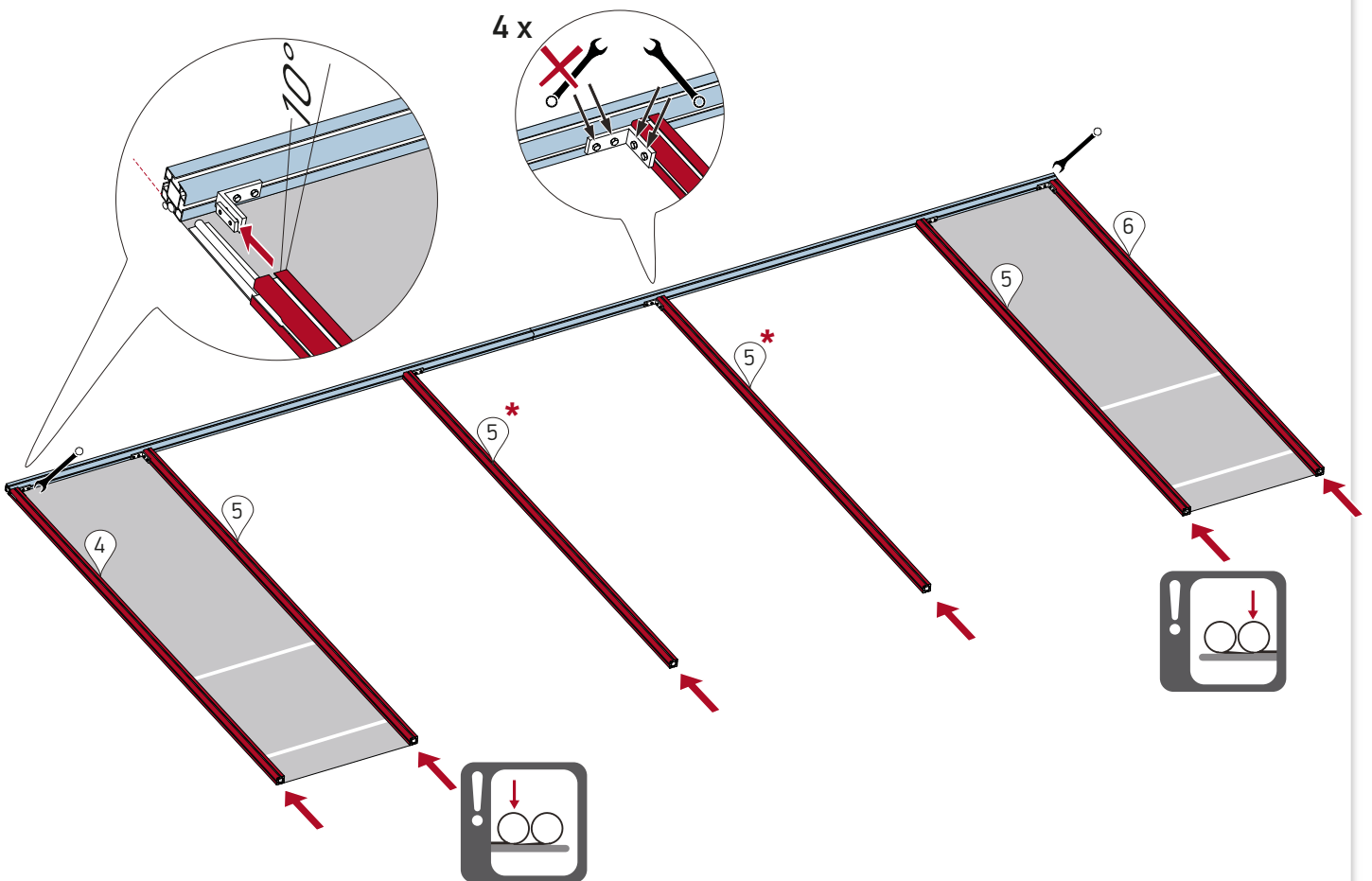

5

4 x



* Villa Connection Tunnel 

6

4 x  14 x 

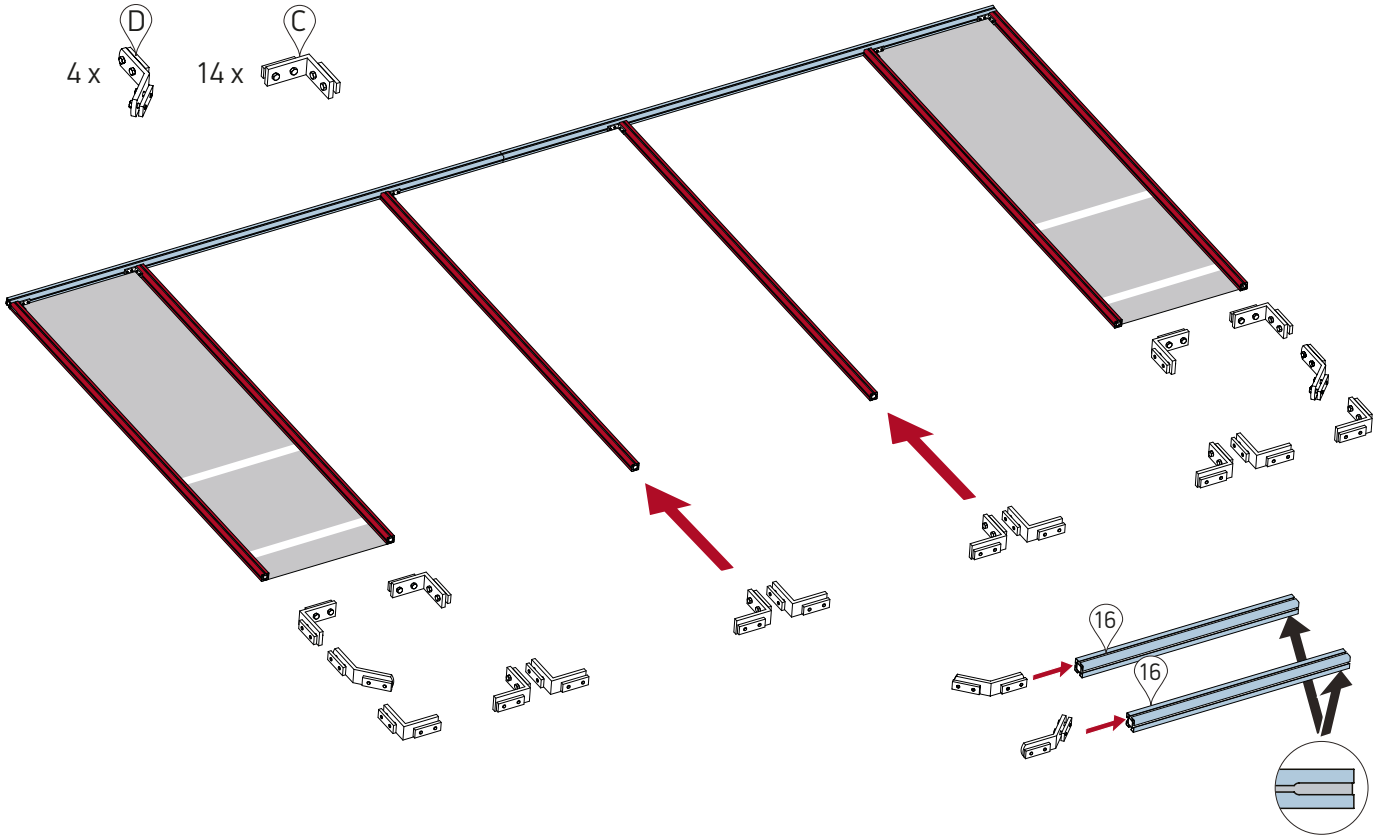

7

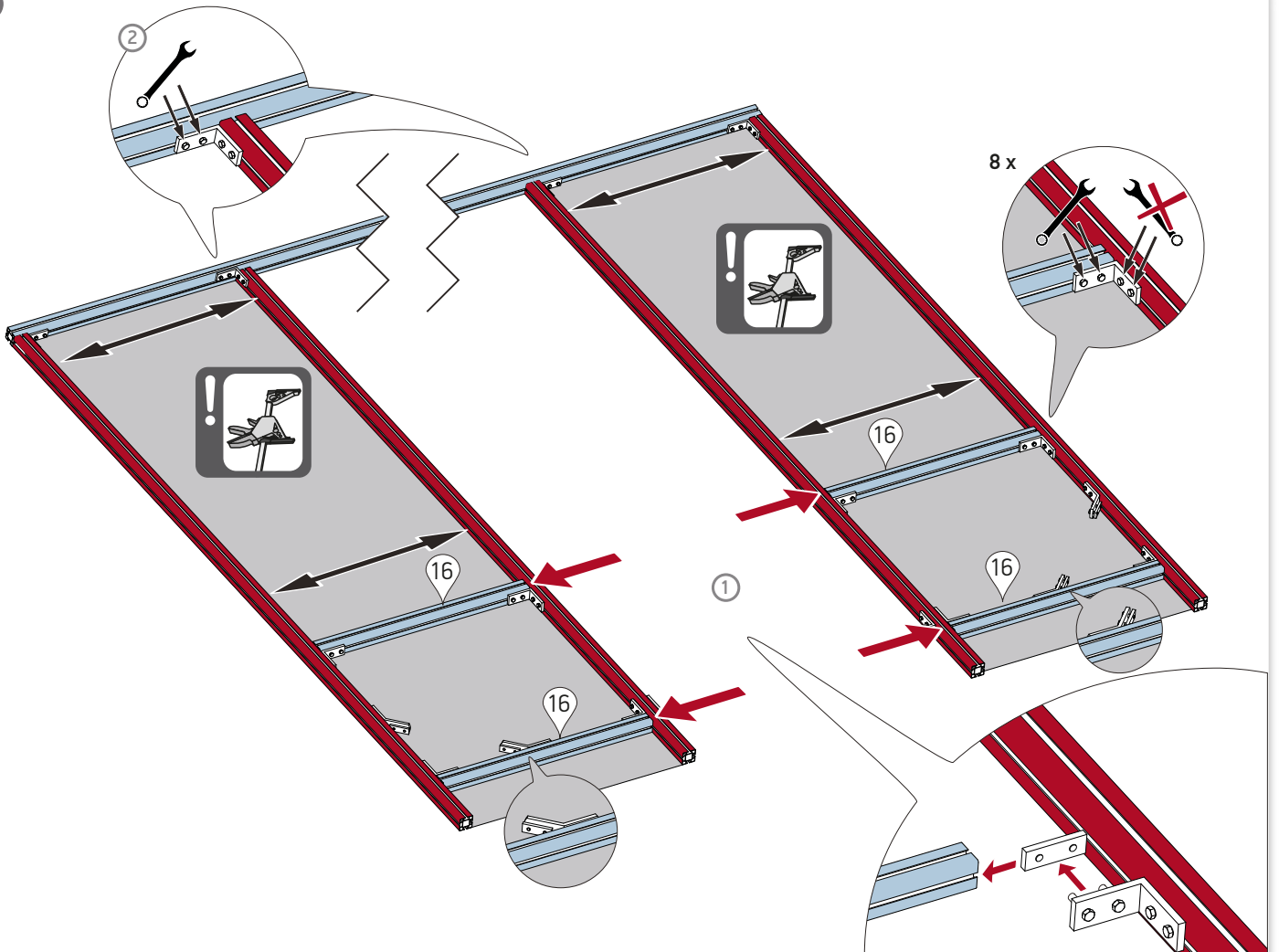

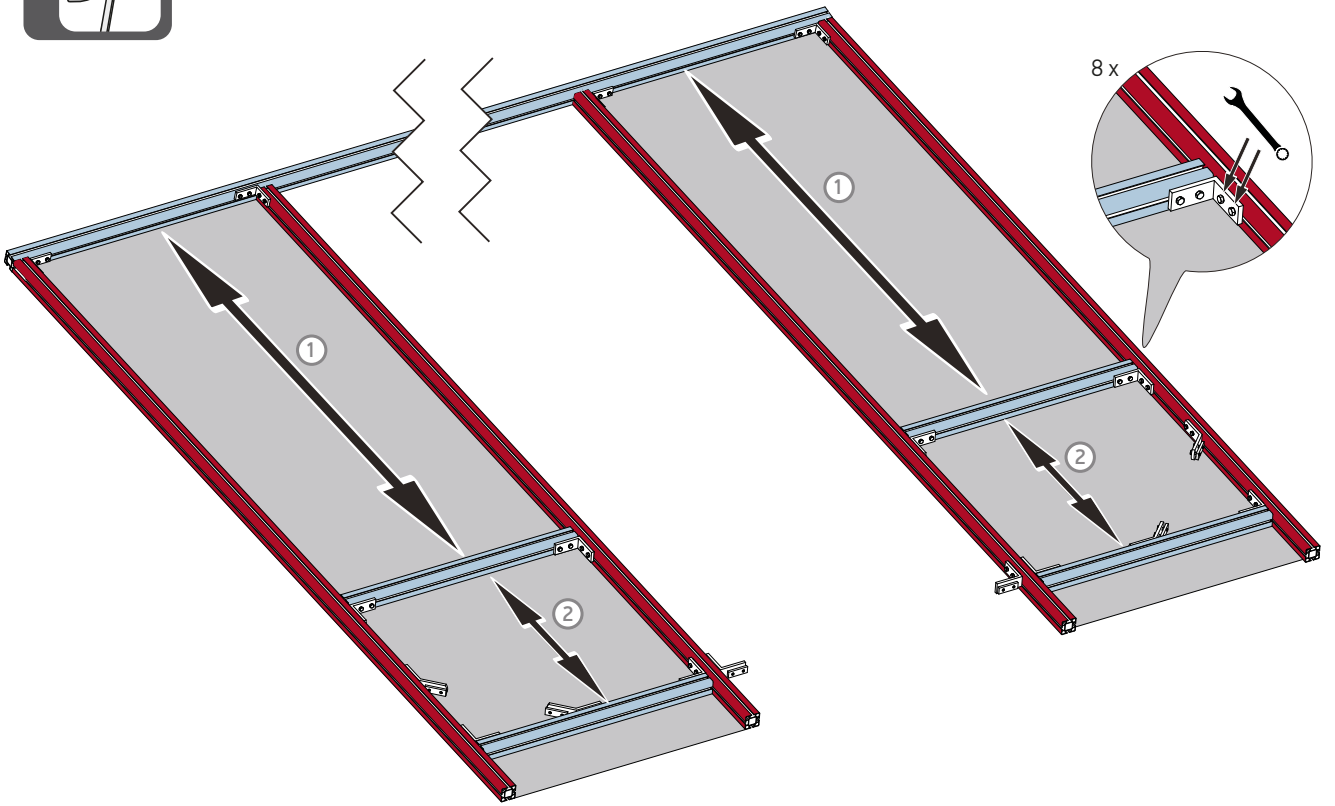

8

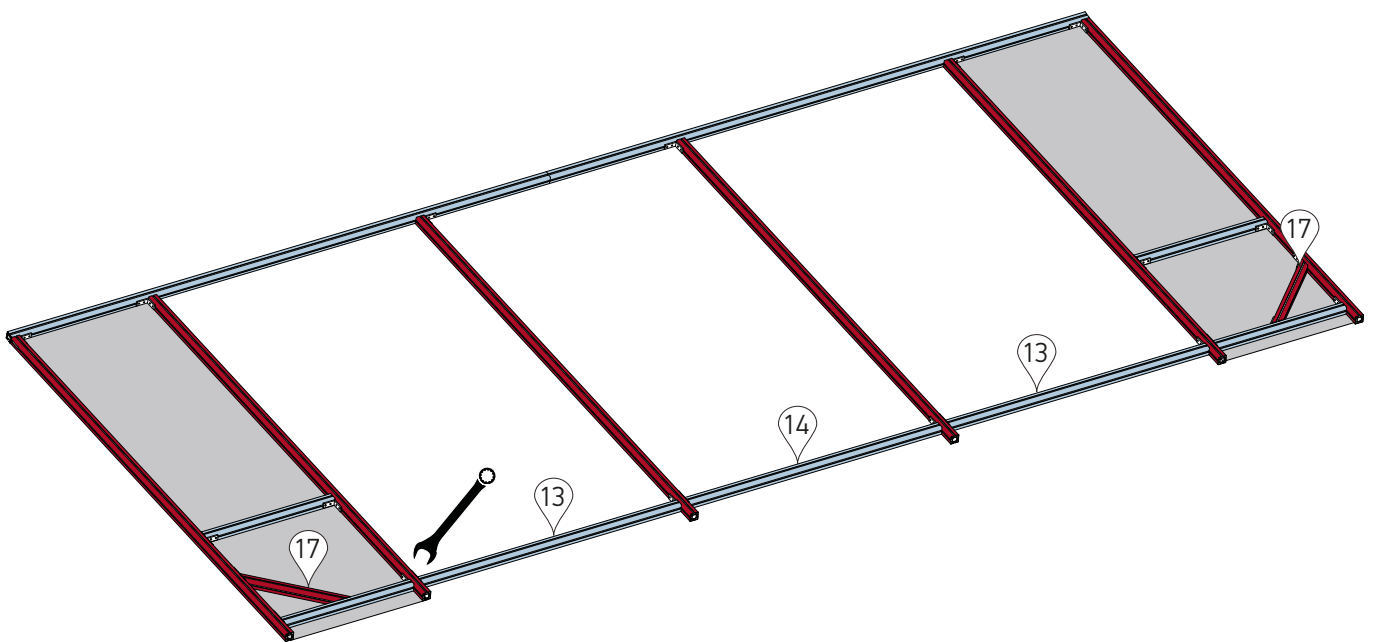

9



10

6 x  4 x  6 x 

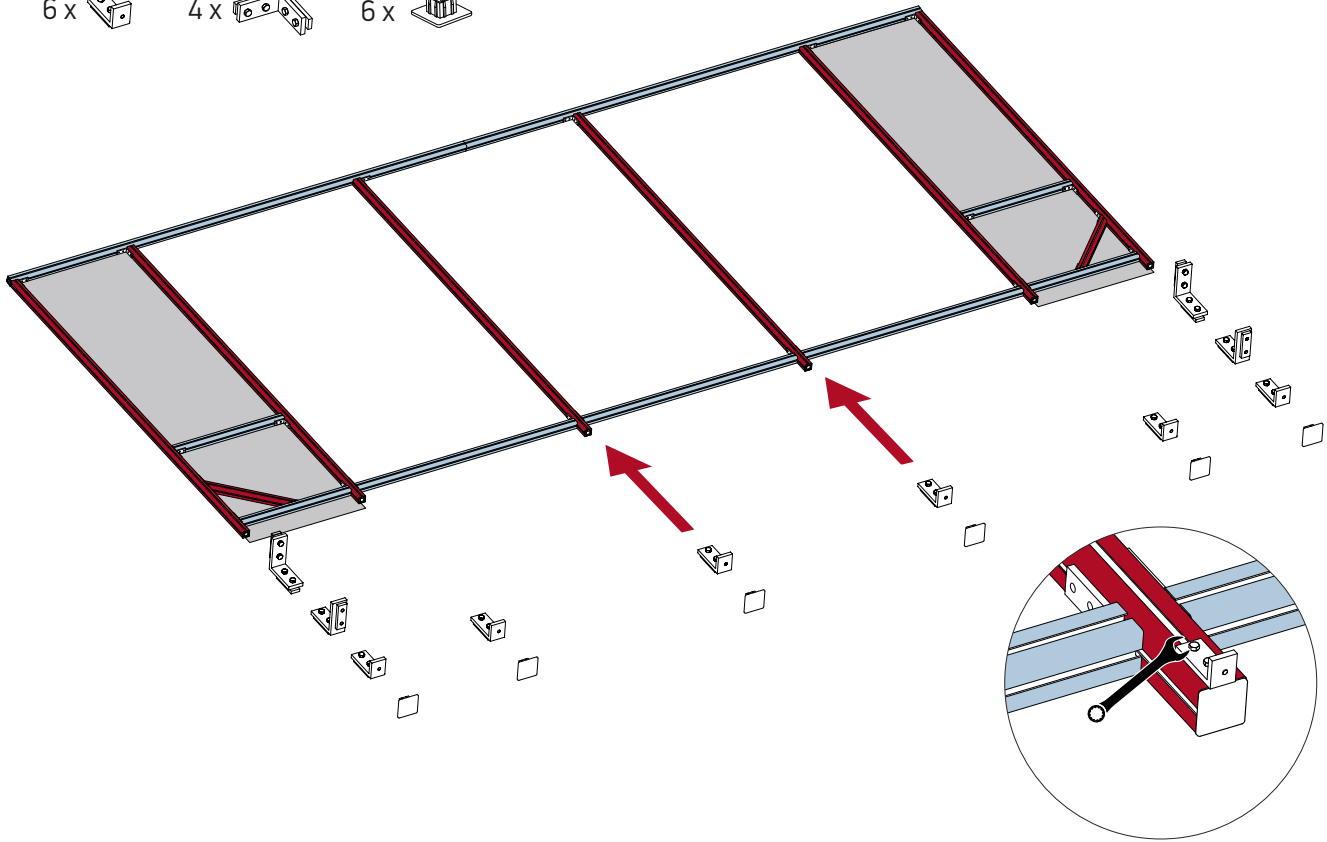

11

Model 550 12 x   Model 650 14 x 

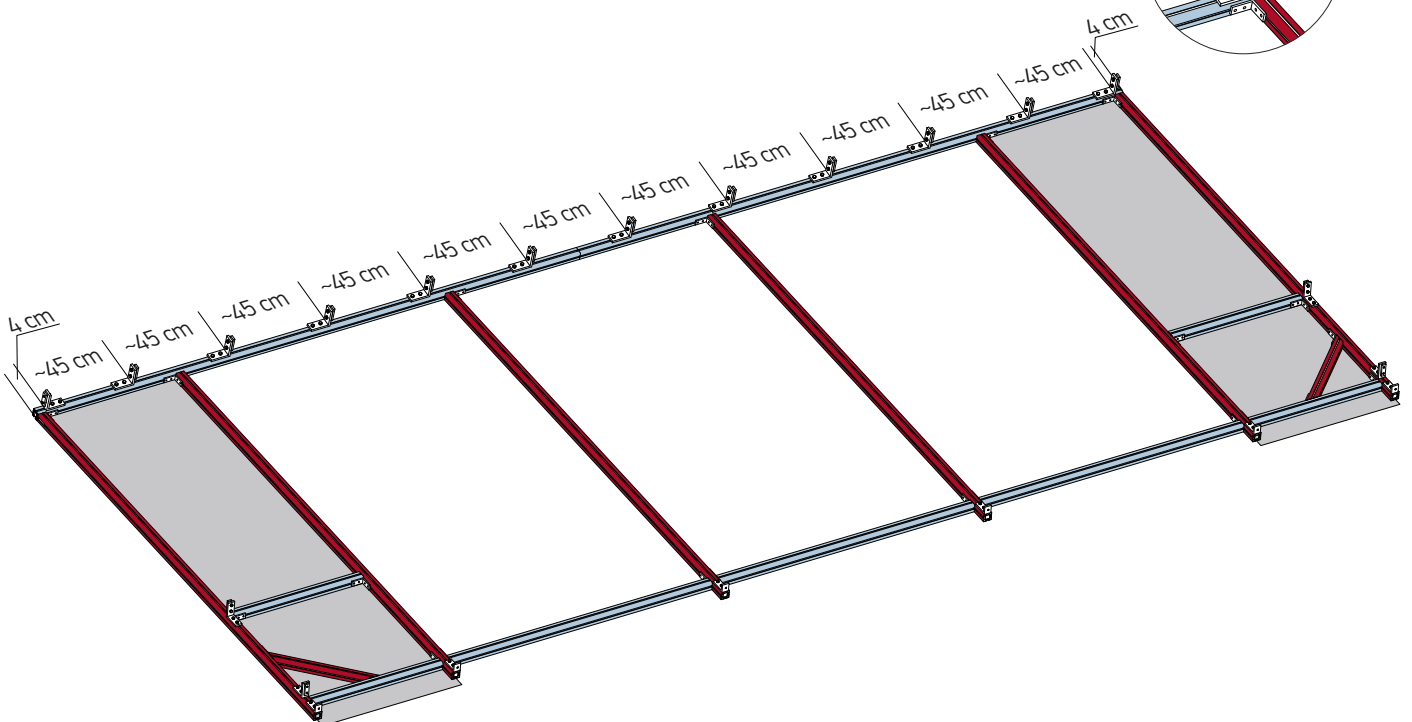

12

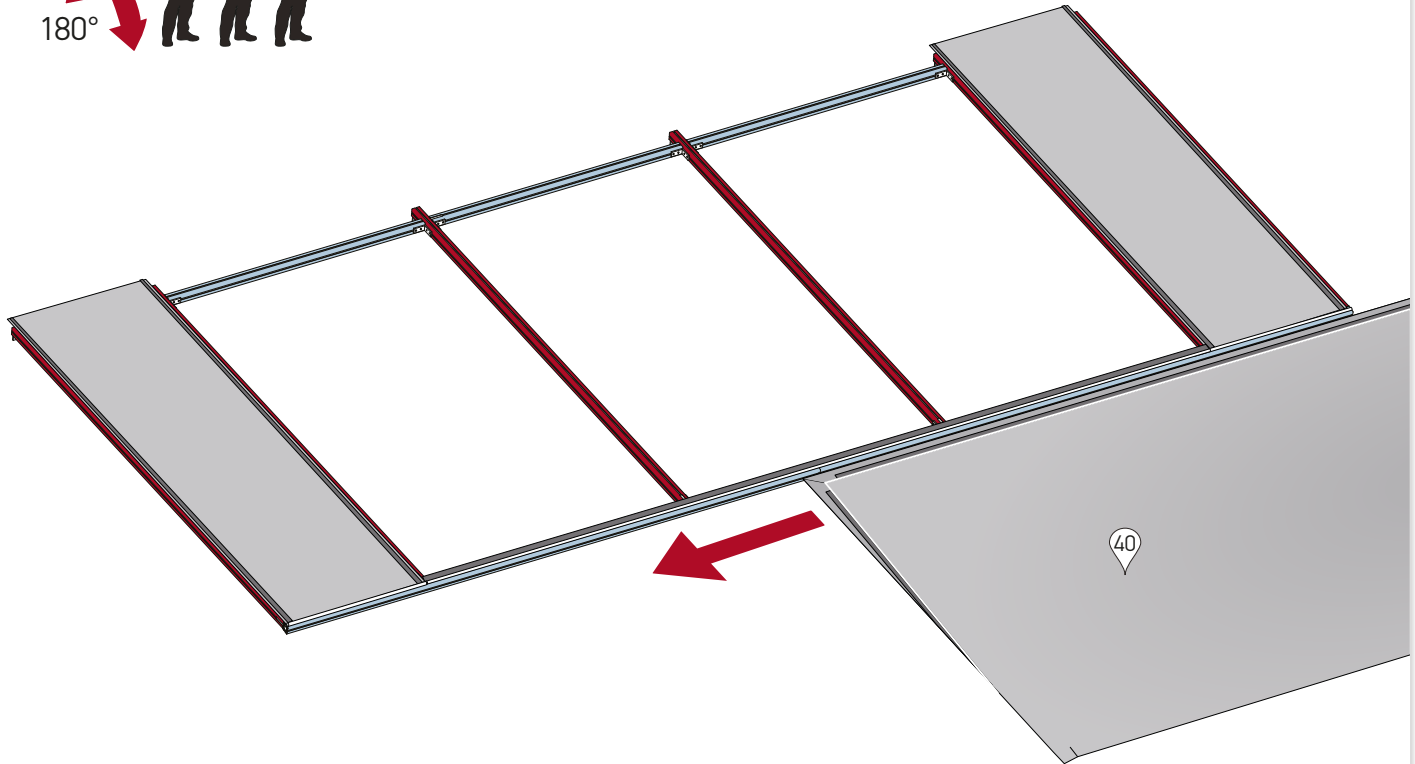

13

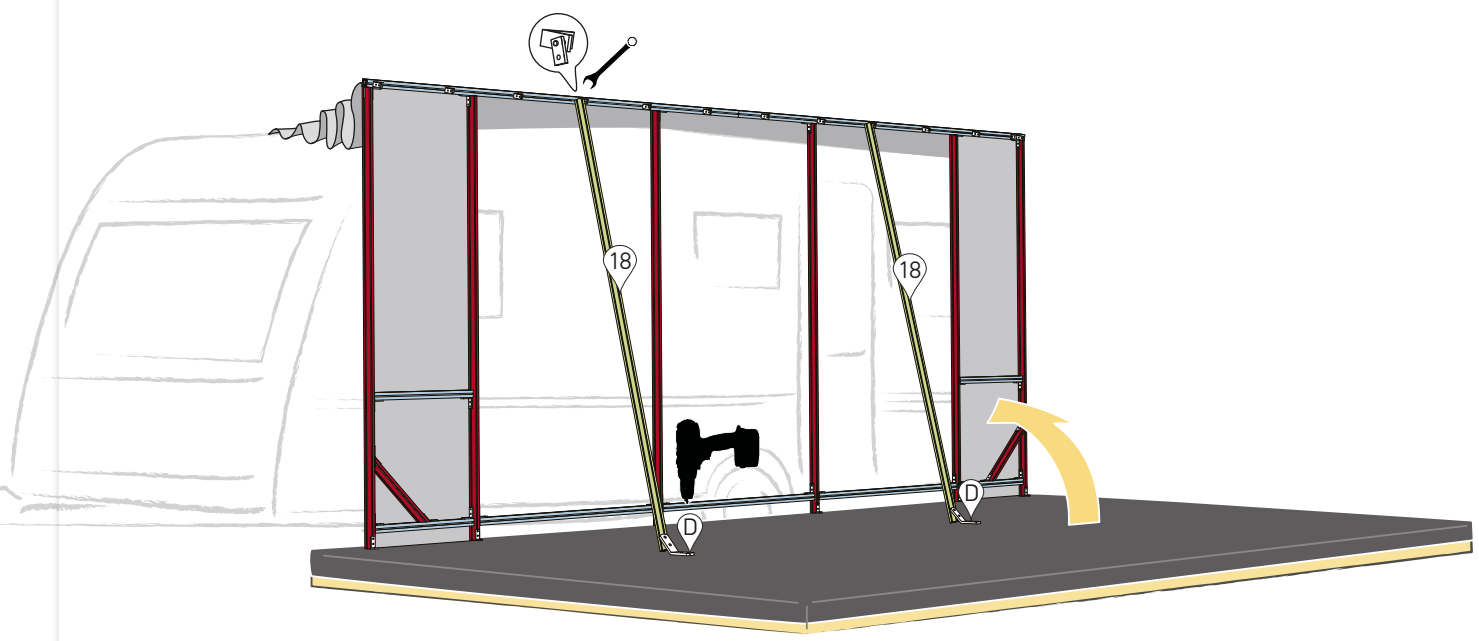

17

2* x  16* x 

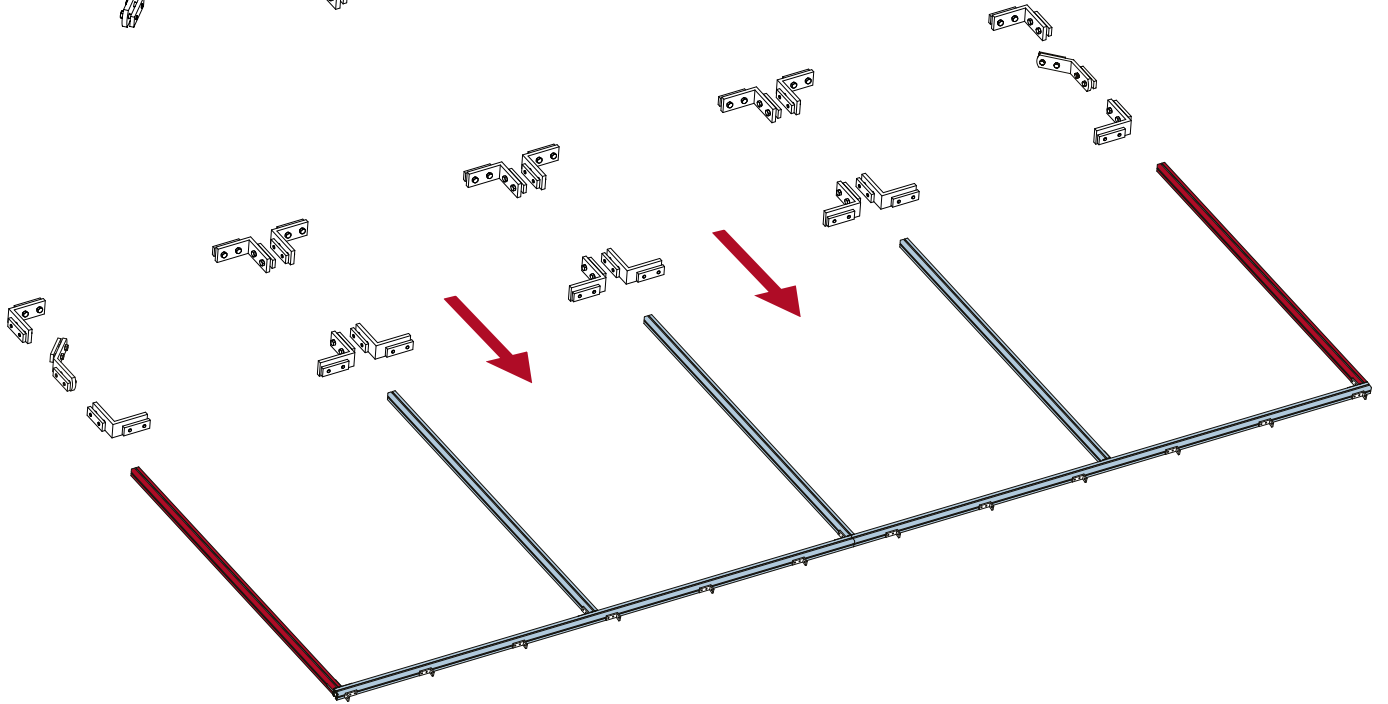

*Afhængig af valg og placering af fronter. Find hjælp på www.isabella.net > support
*Dependent on choice and placement of fronts. Find help at www.isabella.net > support

18

Model 550 5 x  5 x  ! Model 650 6 x  6 x 

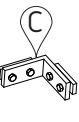
2 x  4 x 

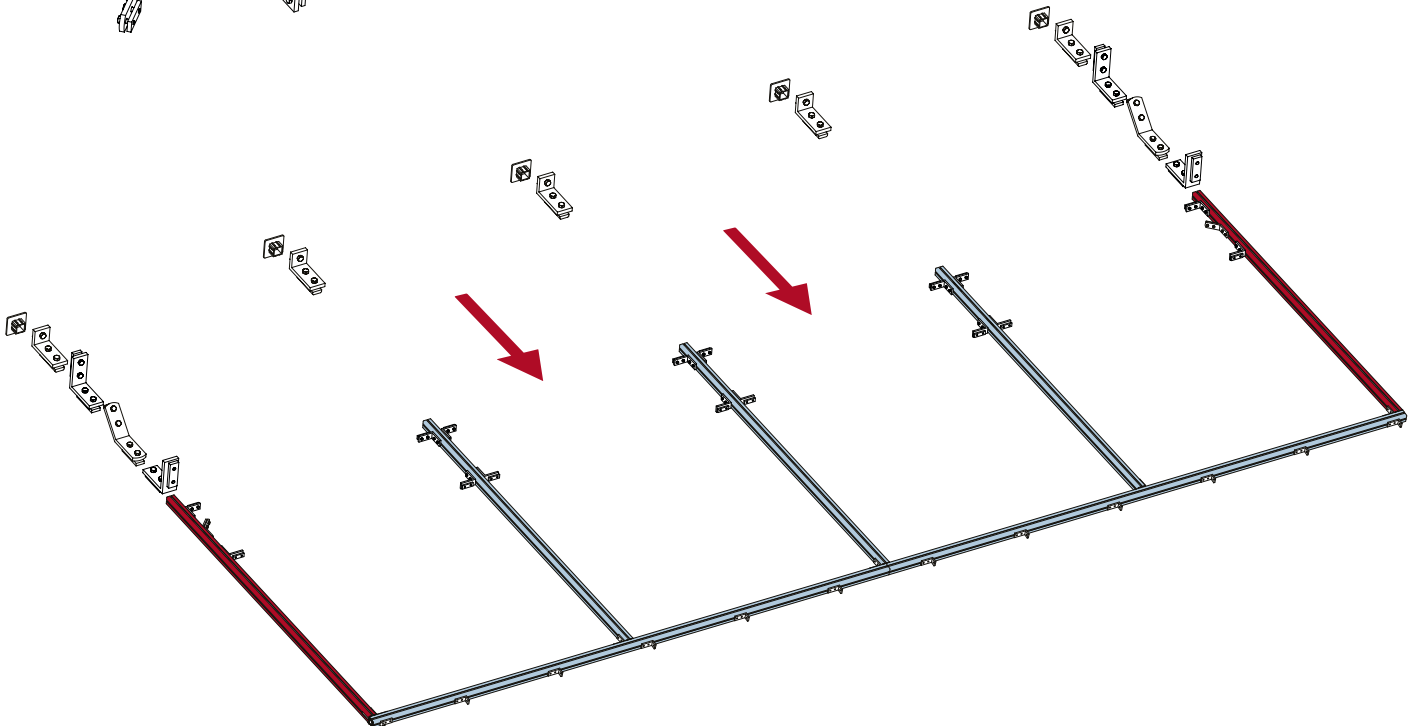

19

4 x 

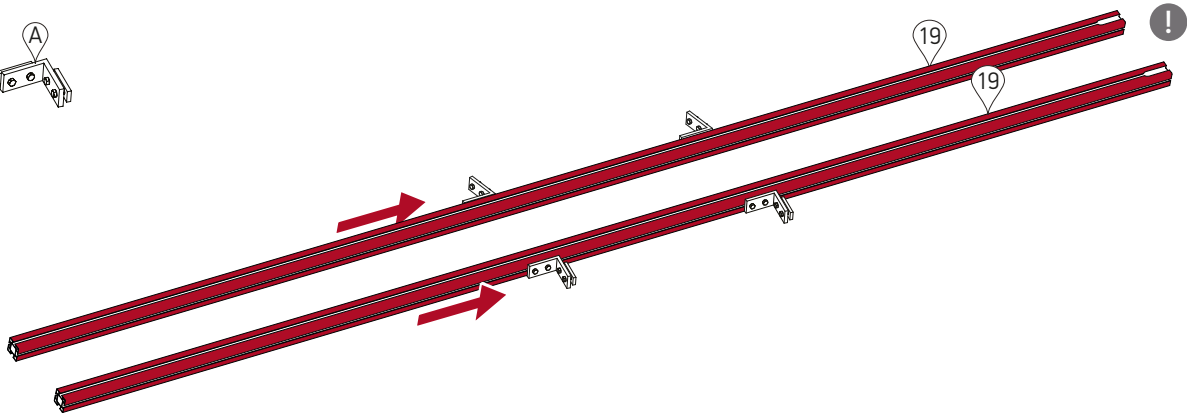

20

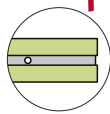
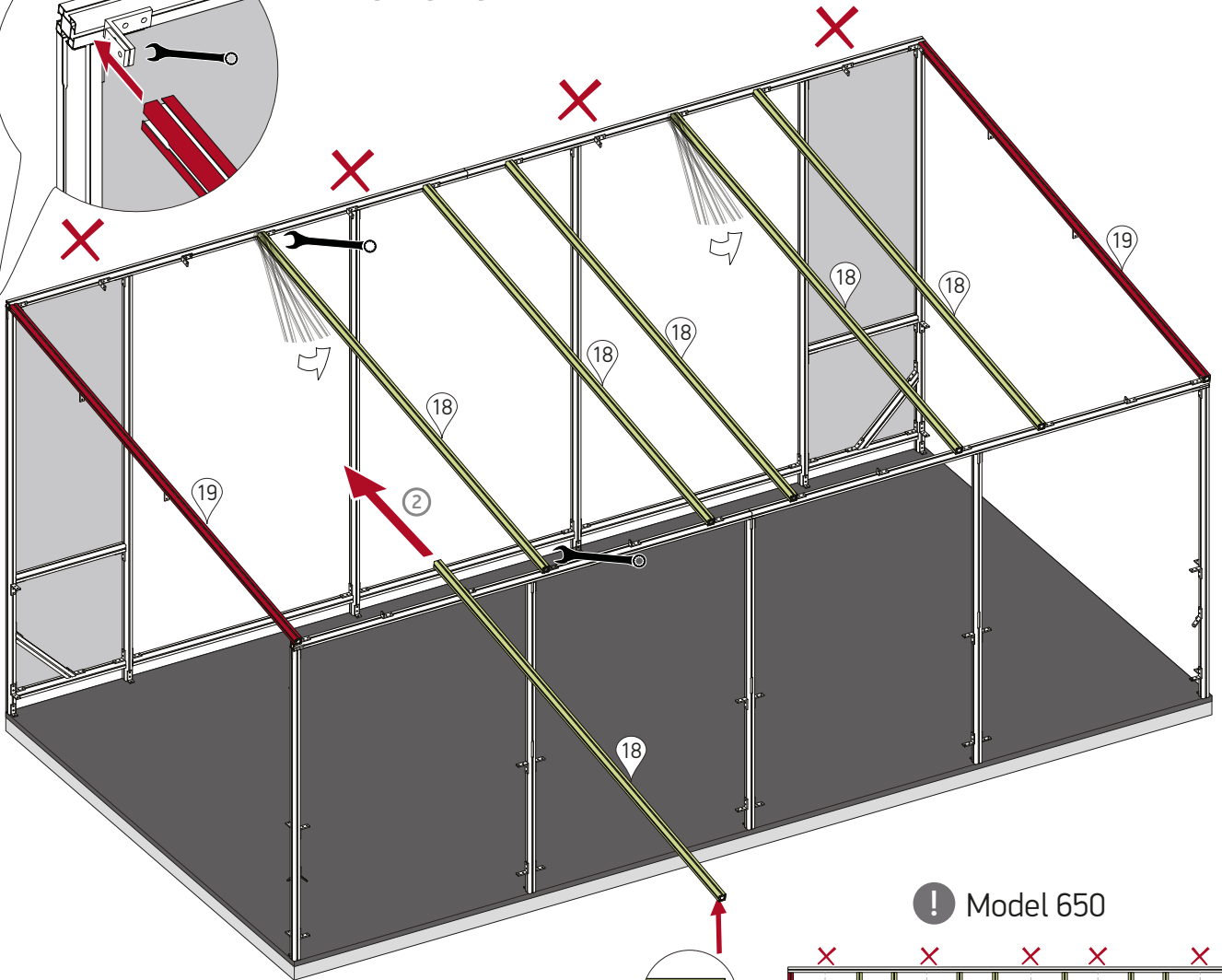
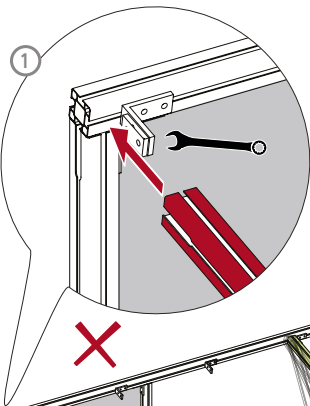

! Model 650

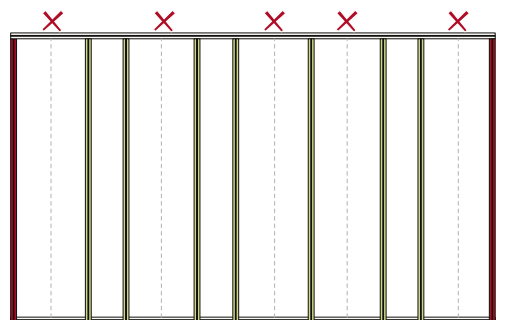

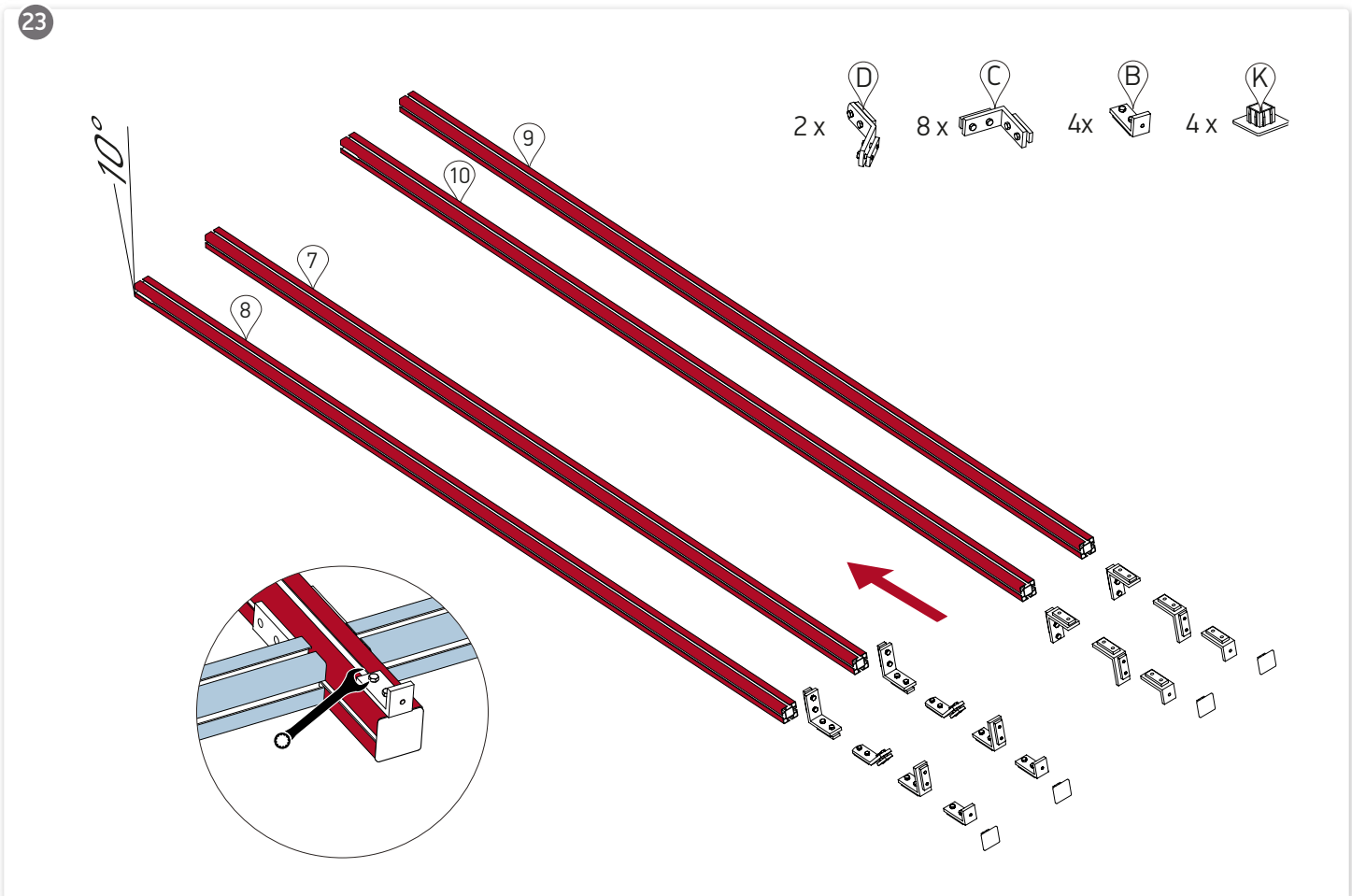
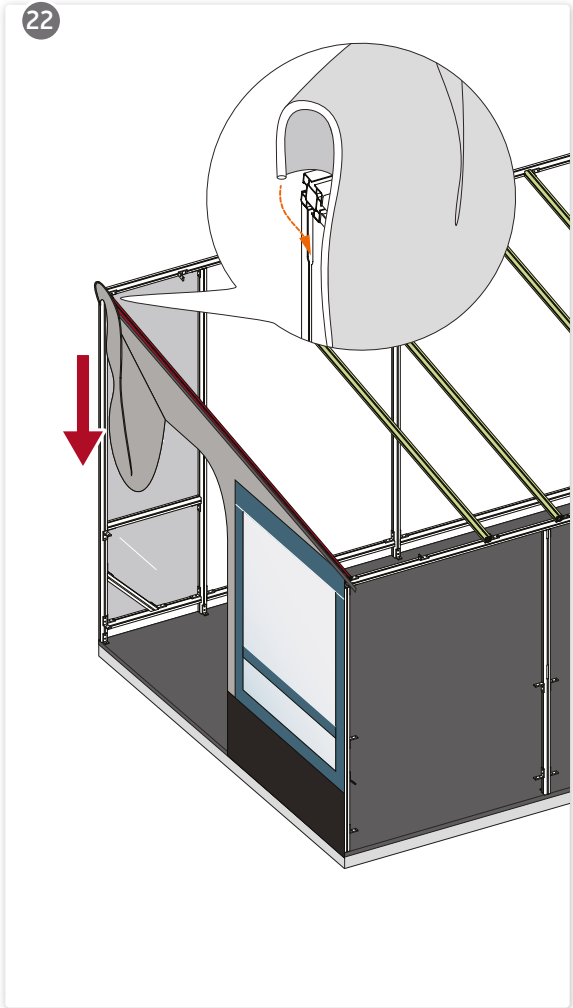
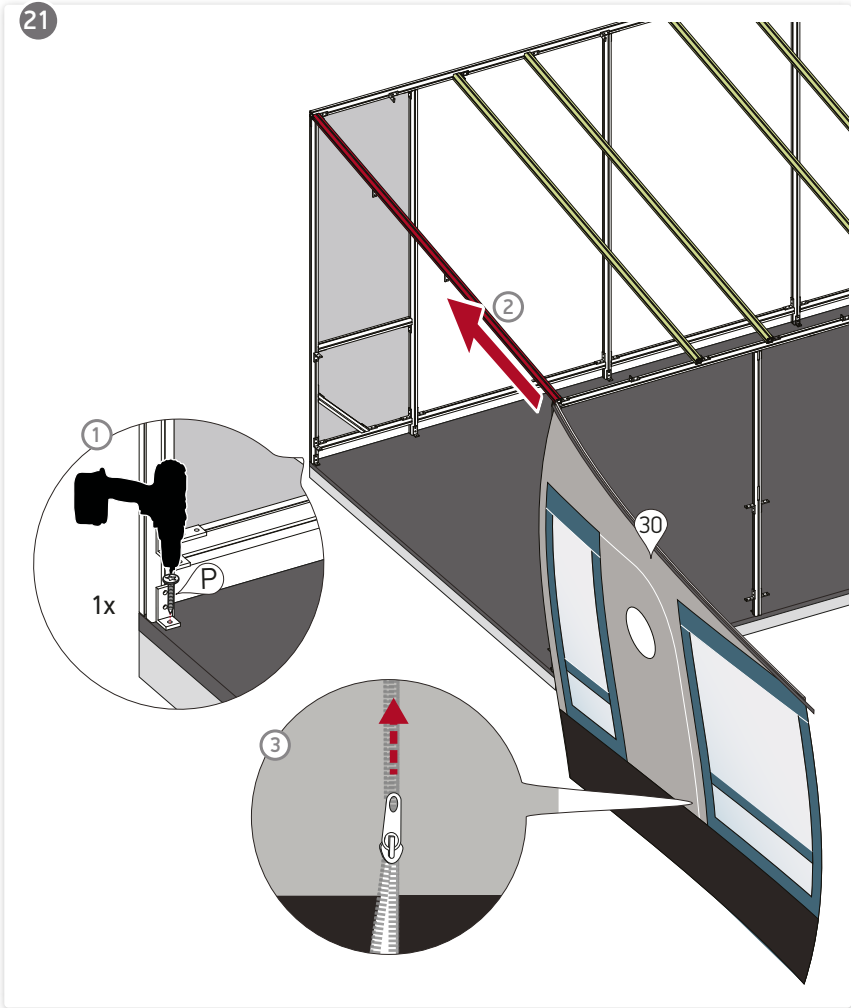

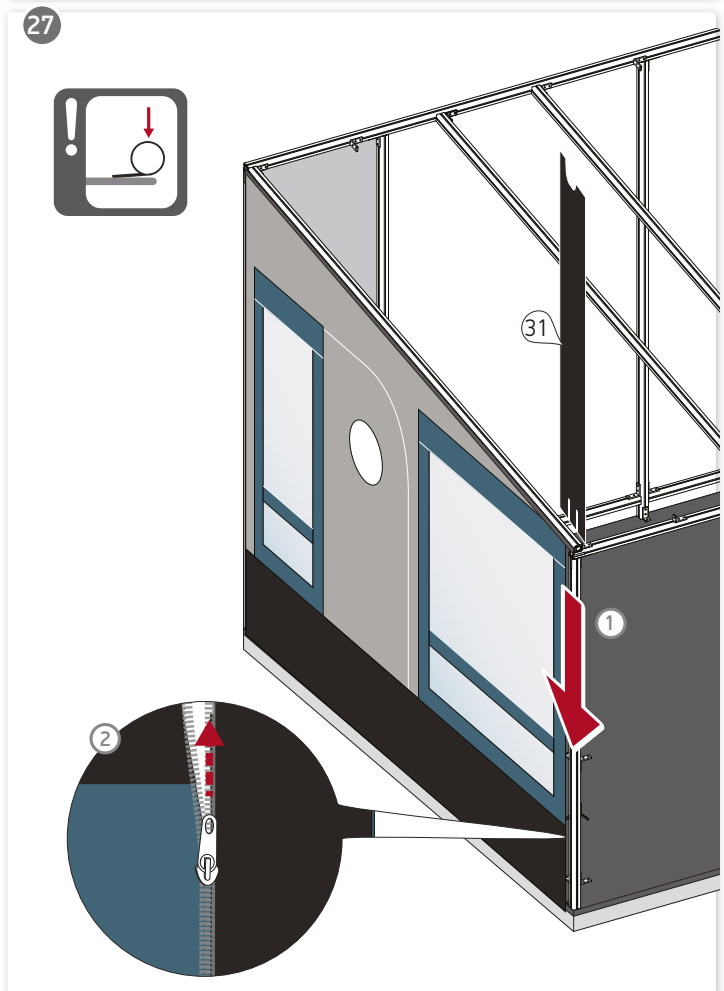
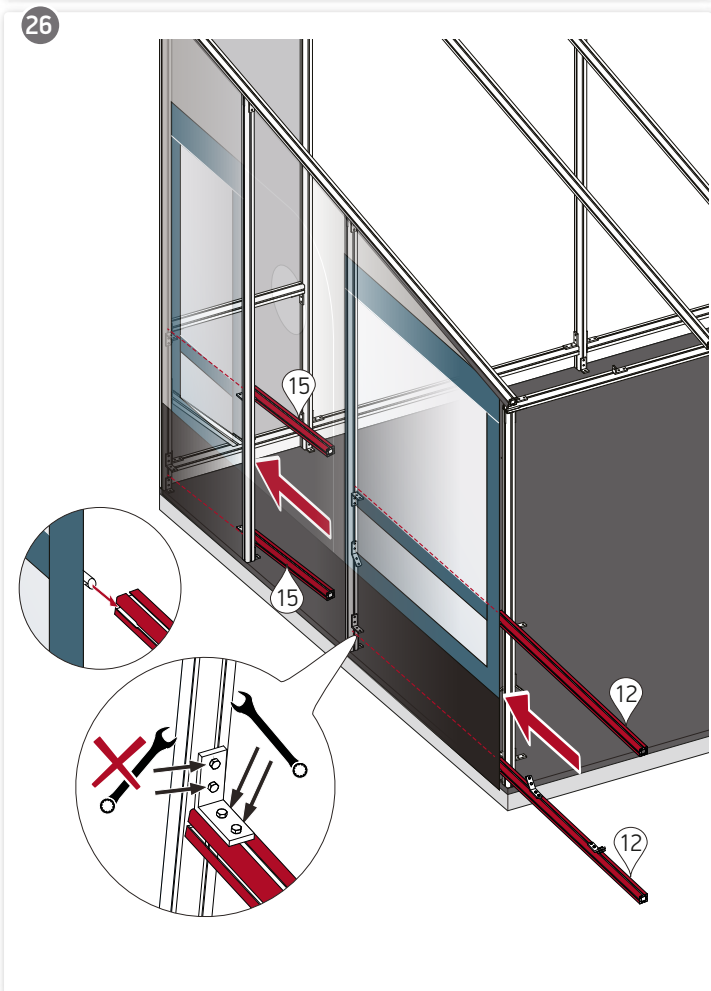
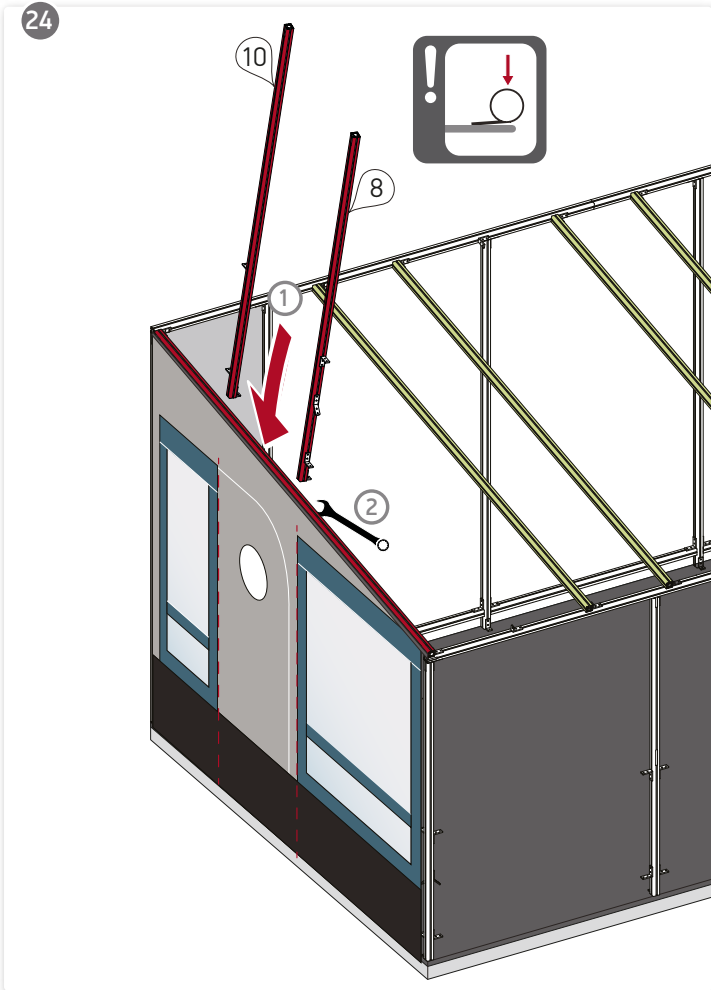

Gentag punkt 21 - 27 for montering af modsatte gavle • Repeat step 21 - 27 for assembly of opposite side

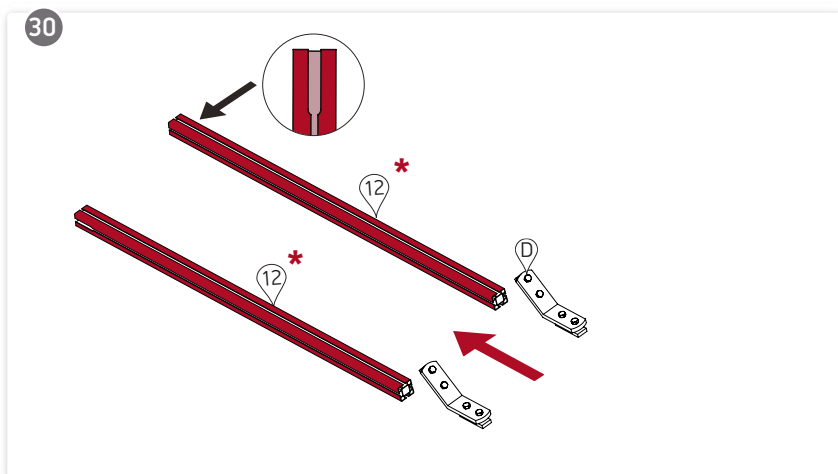
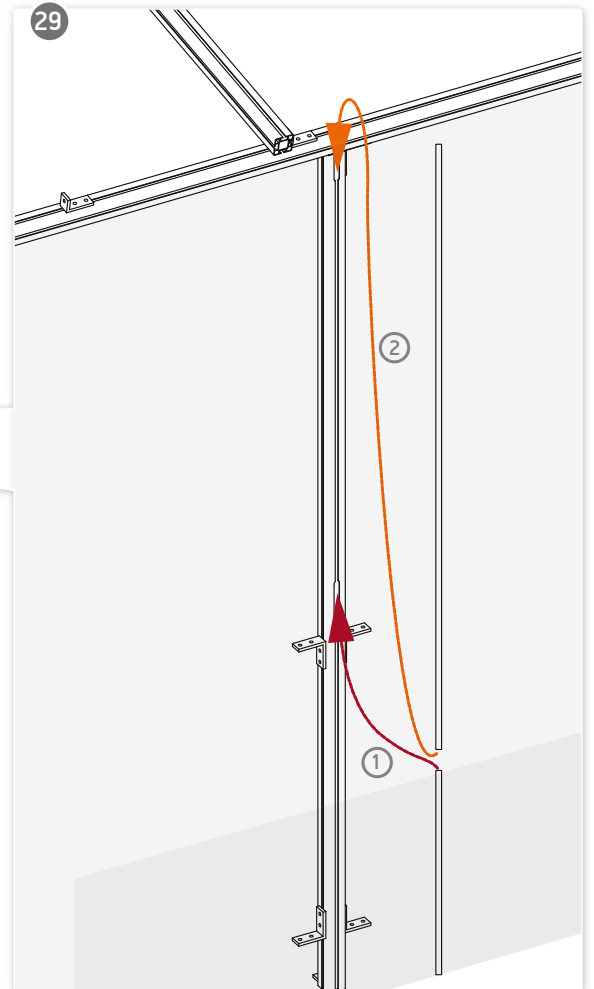
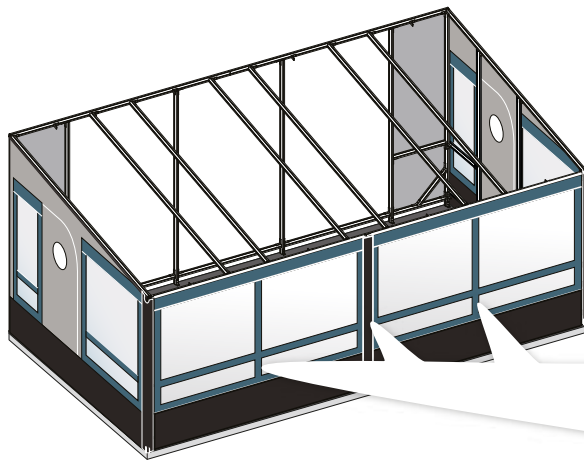
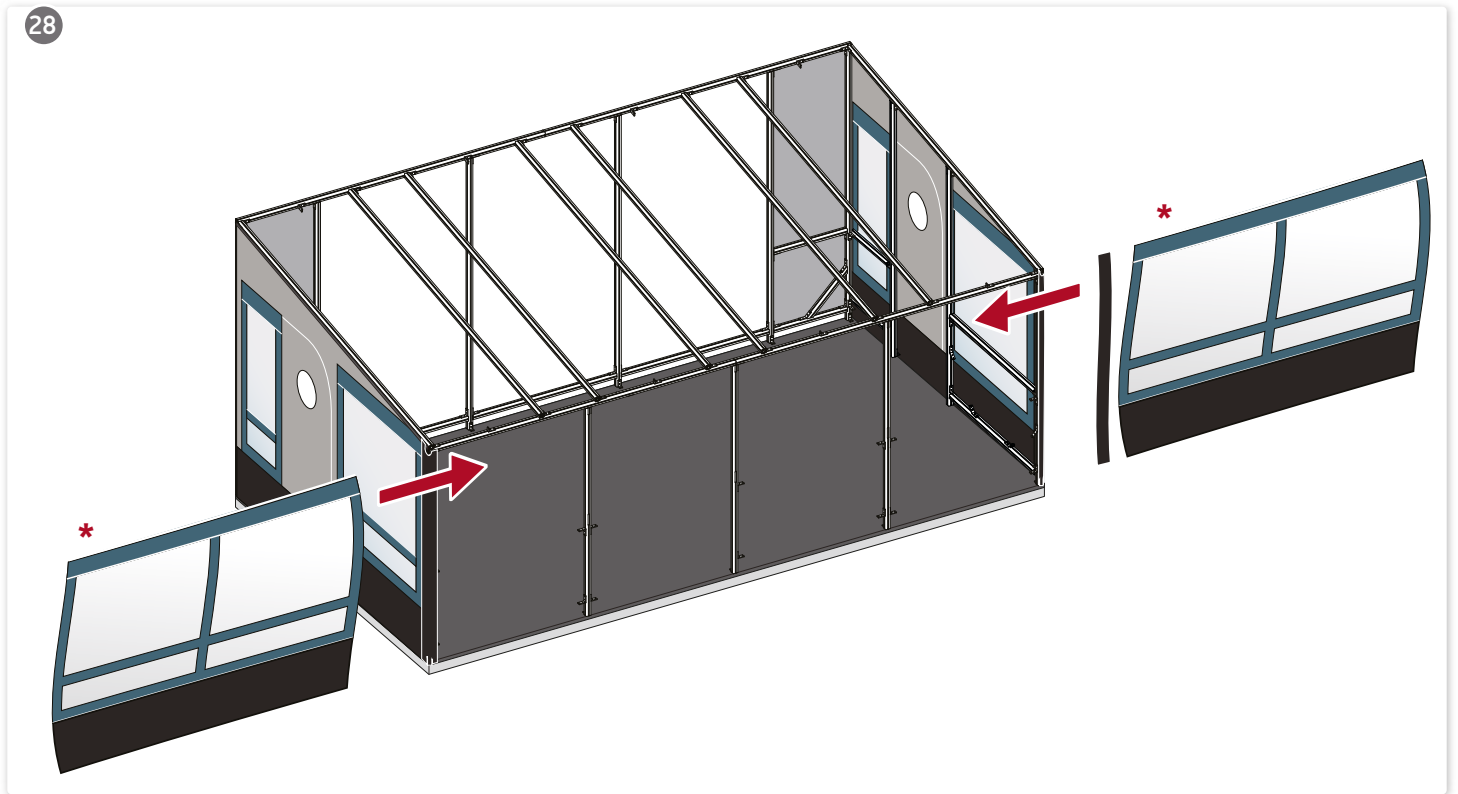

* Afhængig af valg og placering af fronter. Find hjælp på www.isabella.net > support

* Dependent on choice and placement of fronts. Find help at www.isabella.net > support

31



32

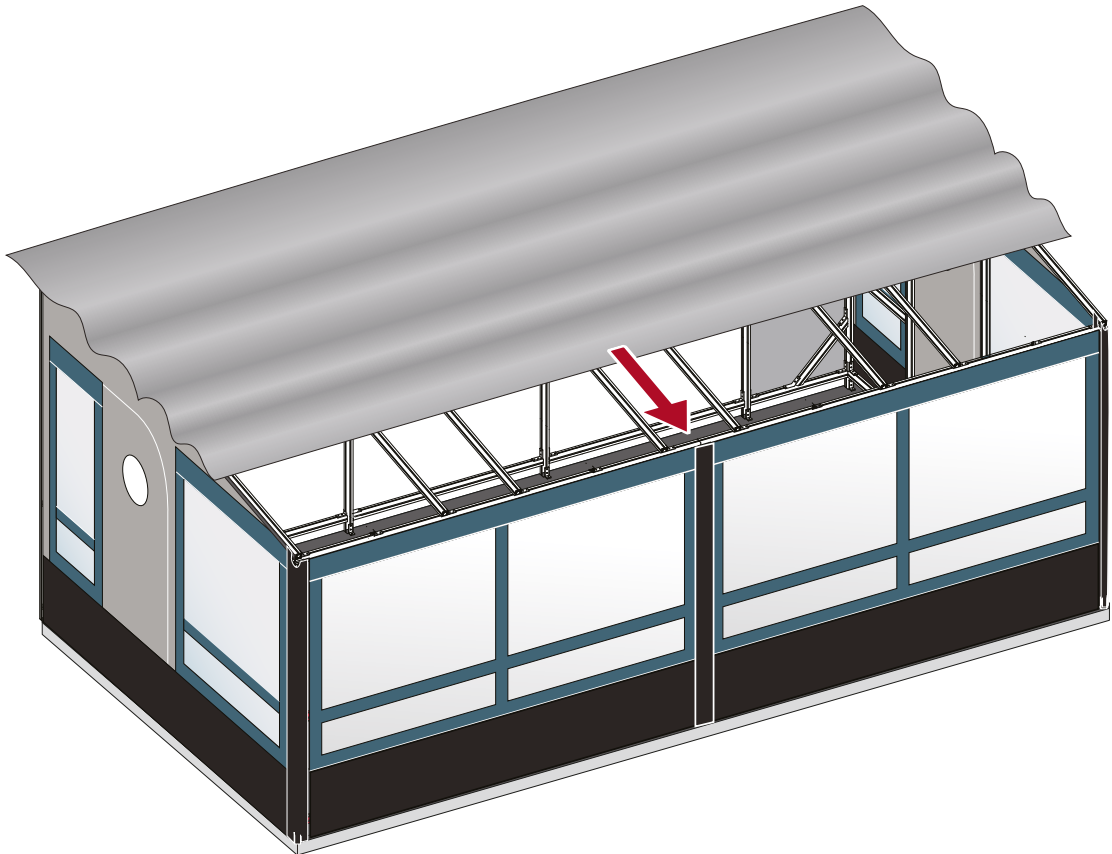

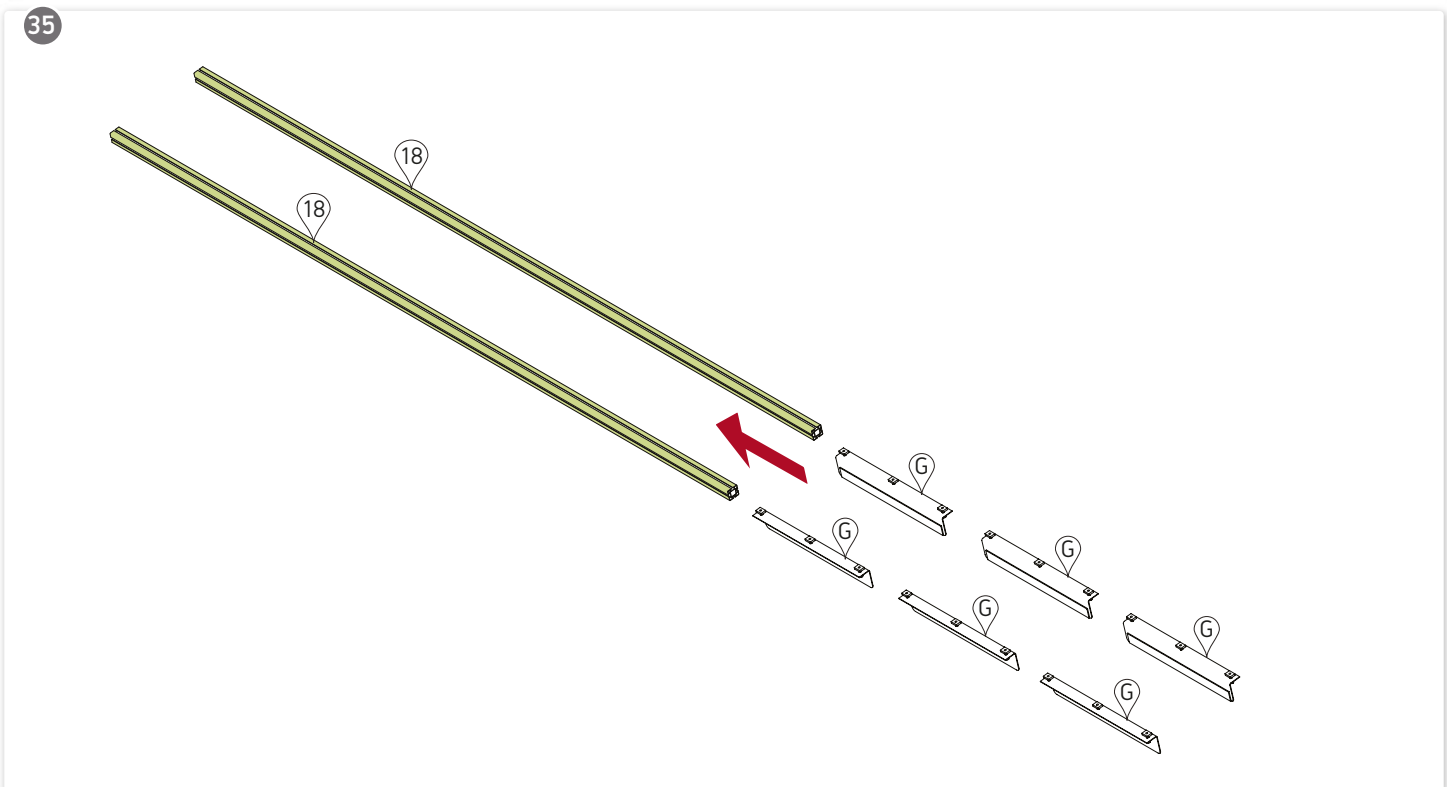
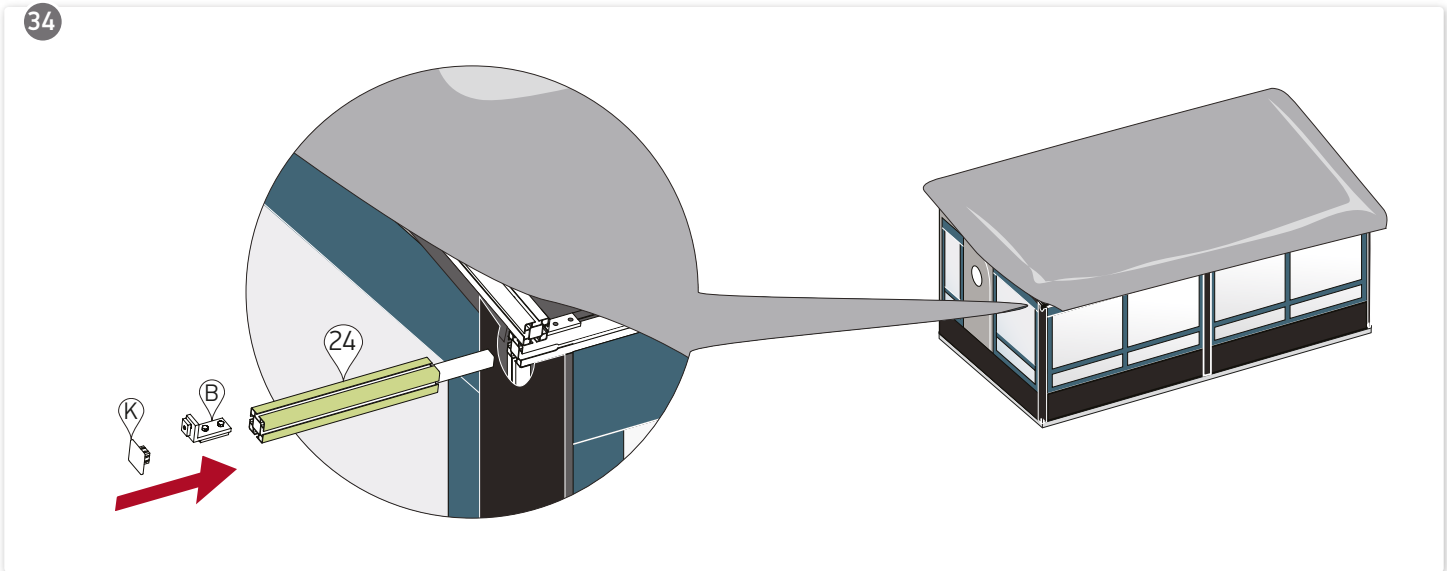
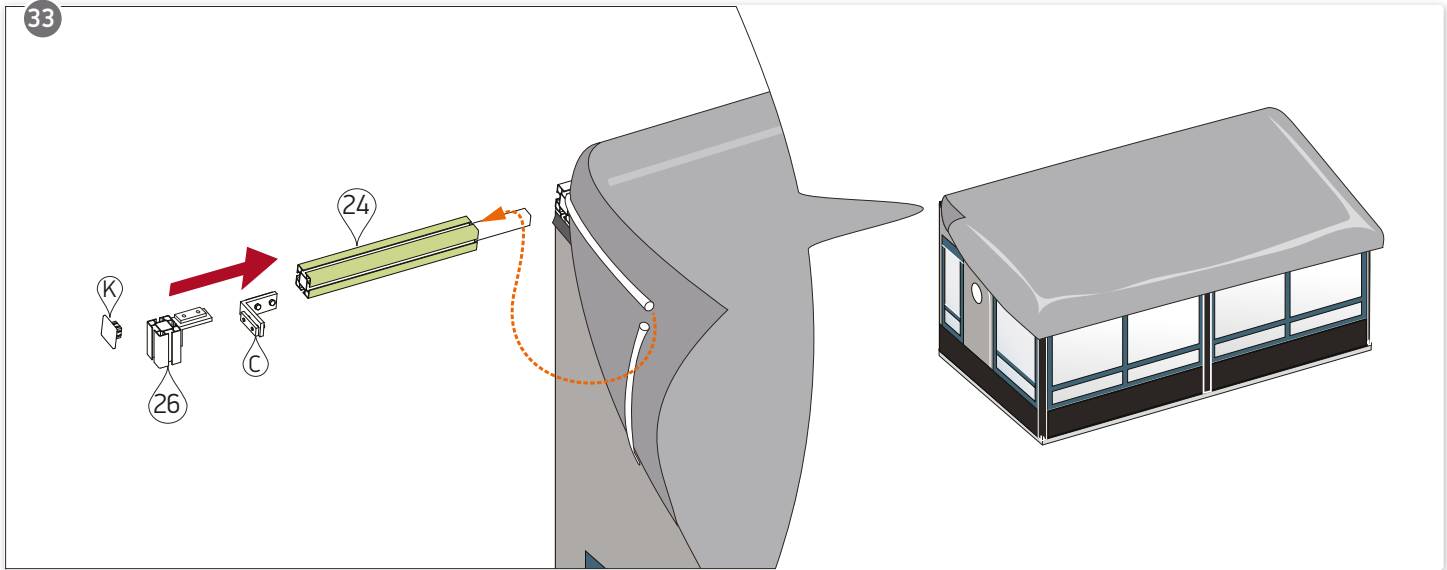

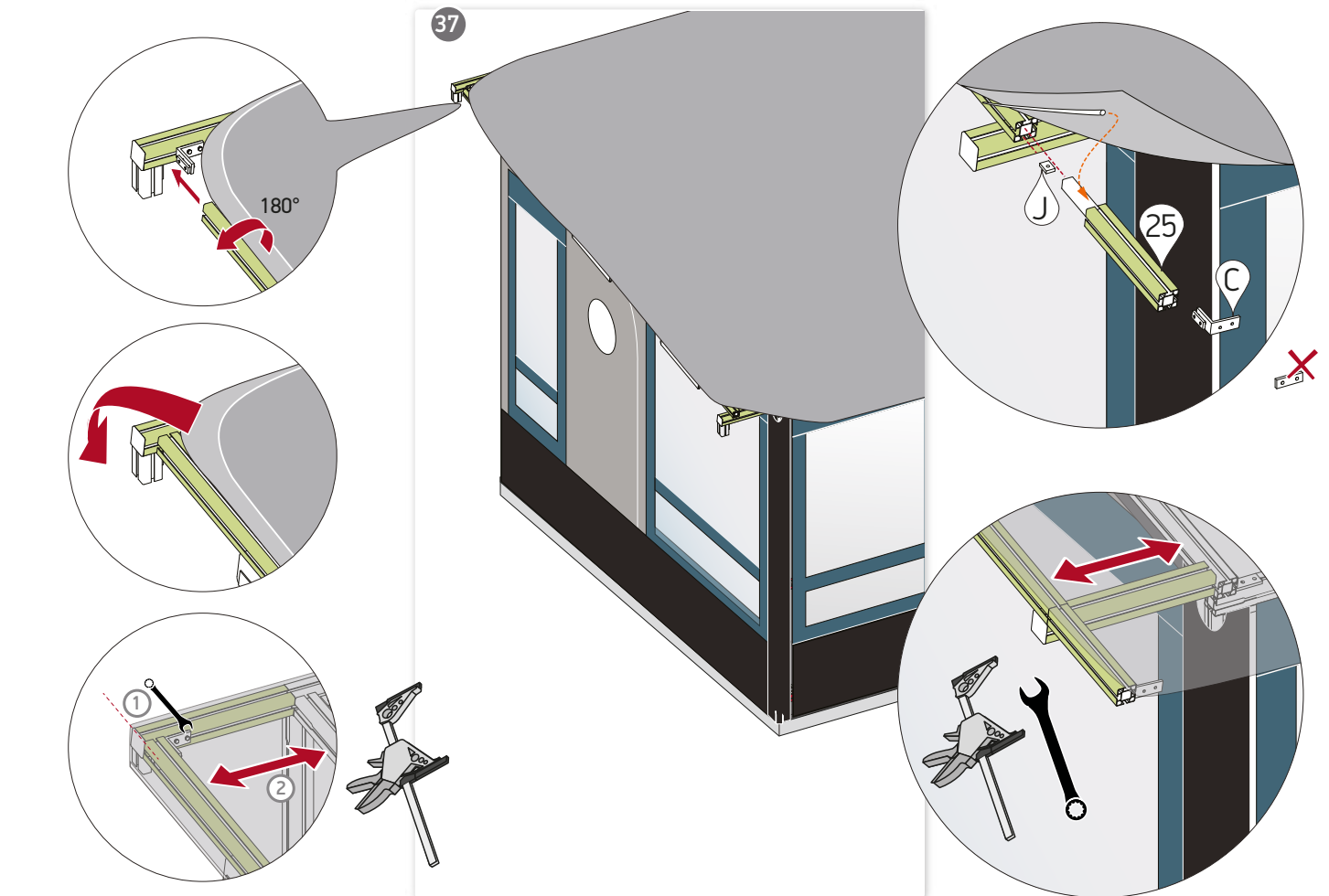
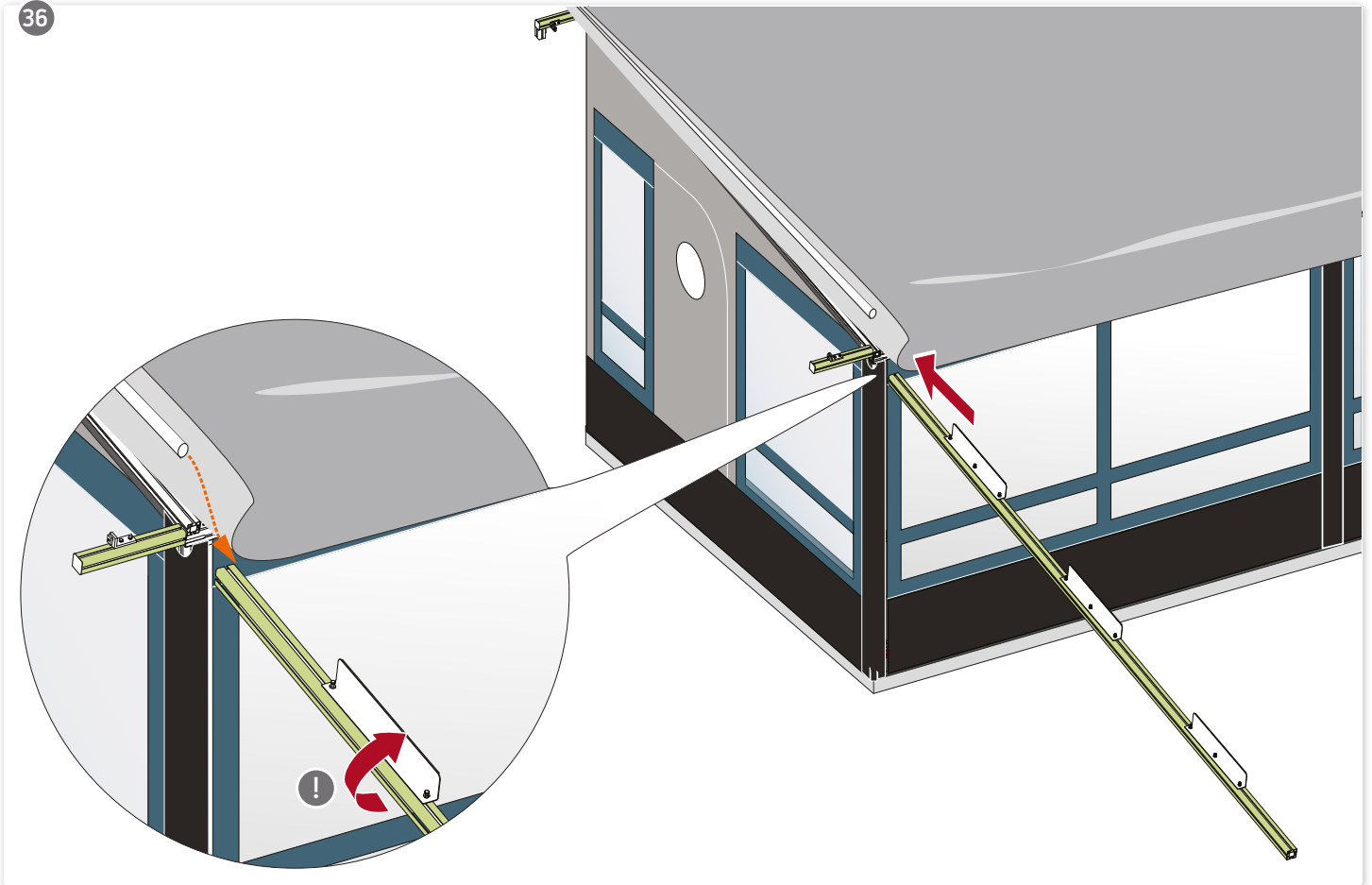

Gentag punkt 33 - 37 for montering af modsatte gavludhæng • Repeat step 33 - 37 for assembly of opposite side overhang

38

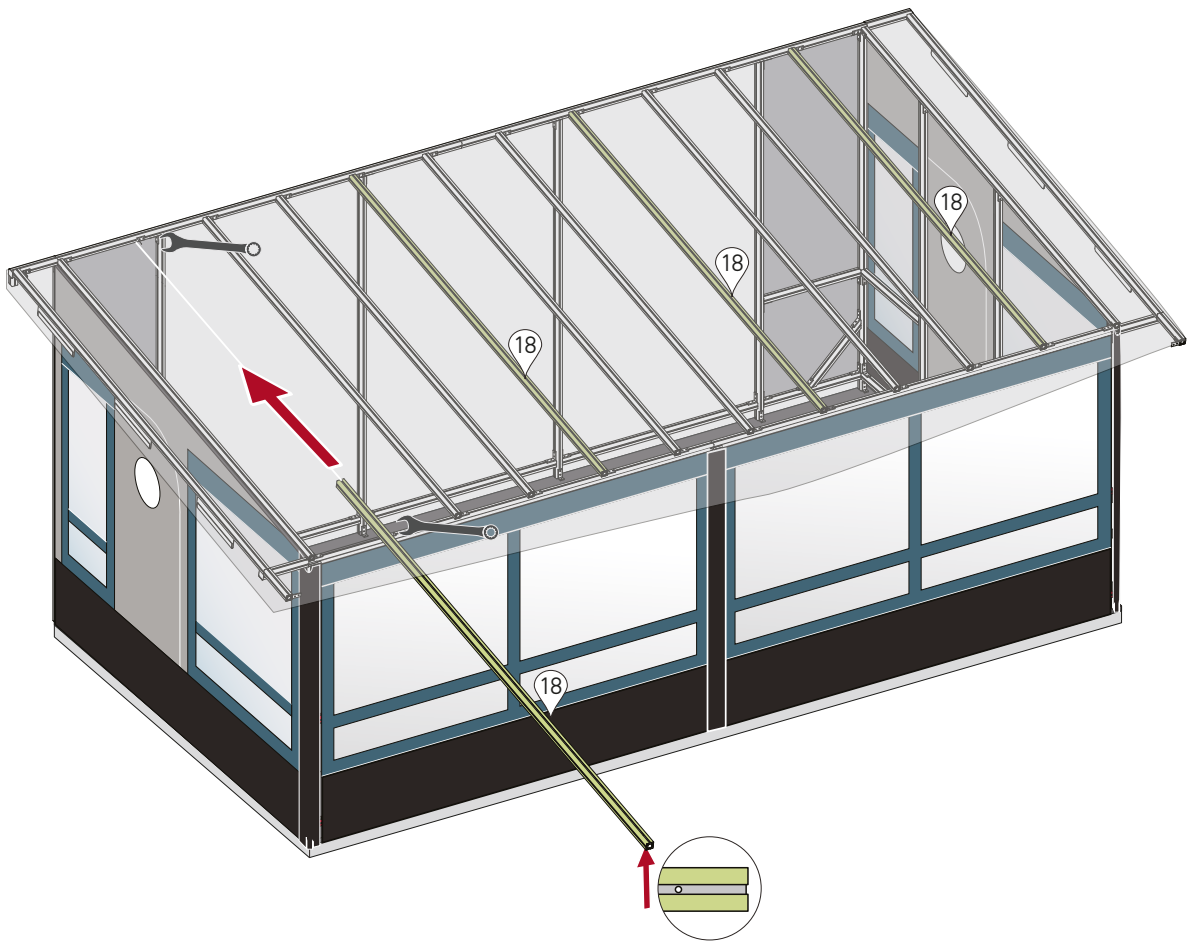

39

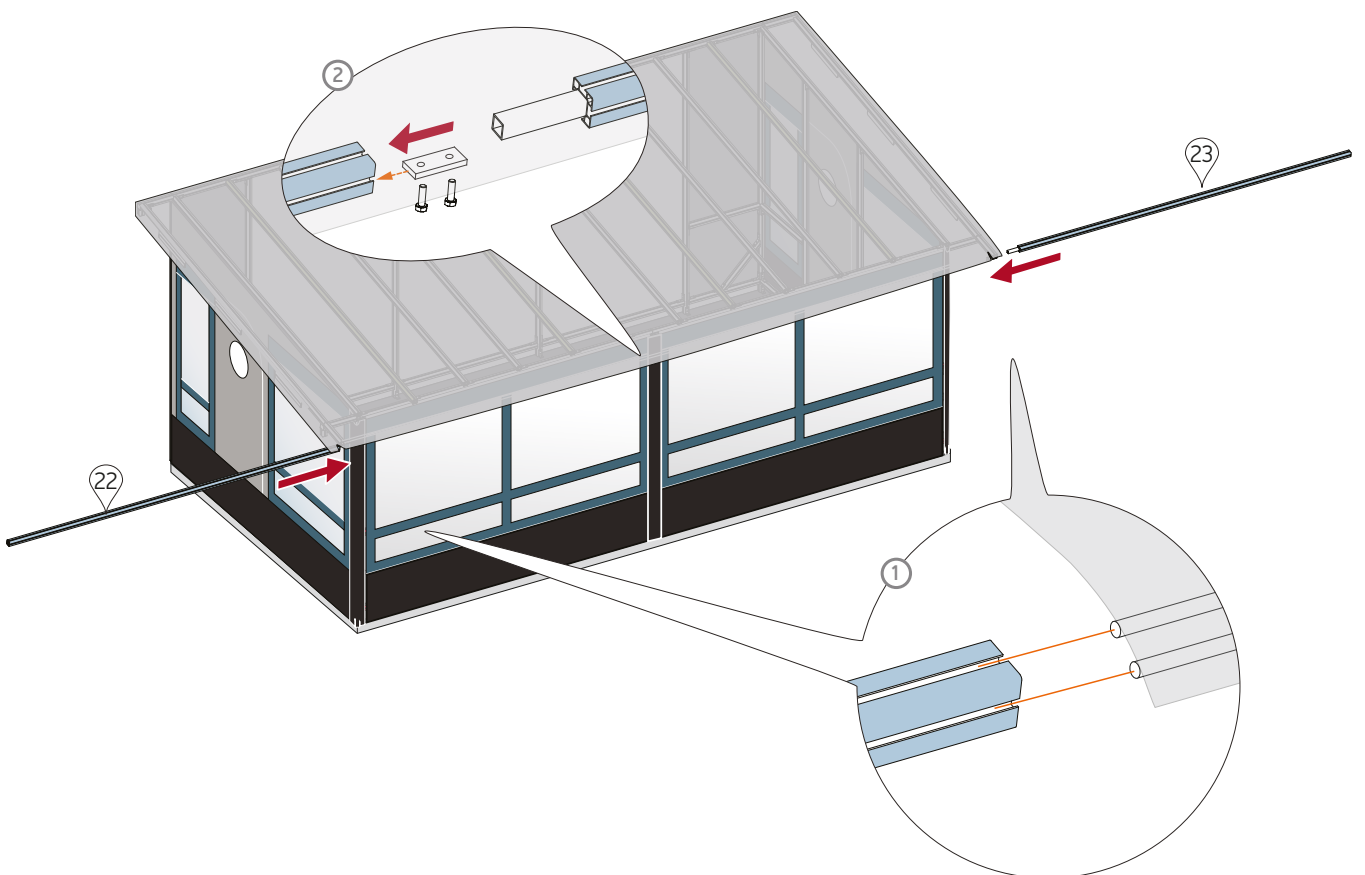

40

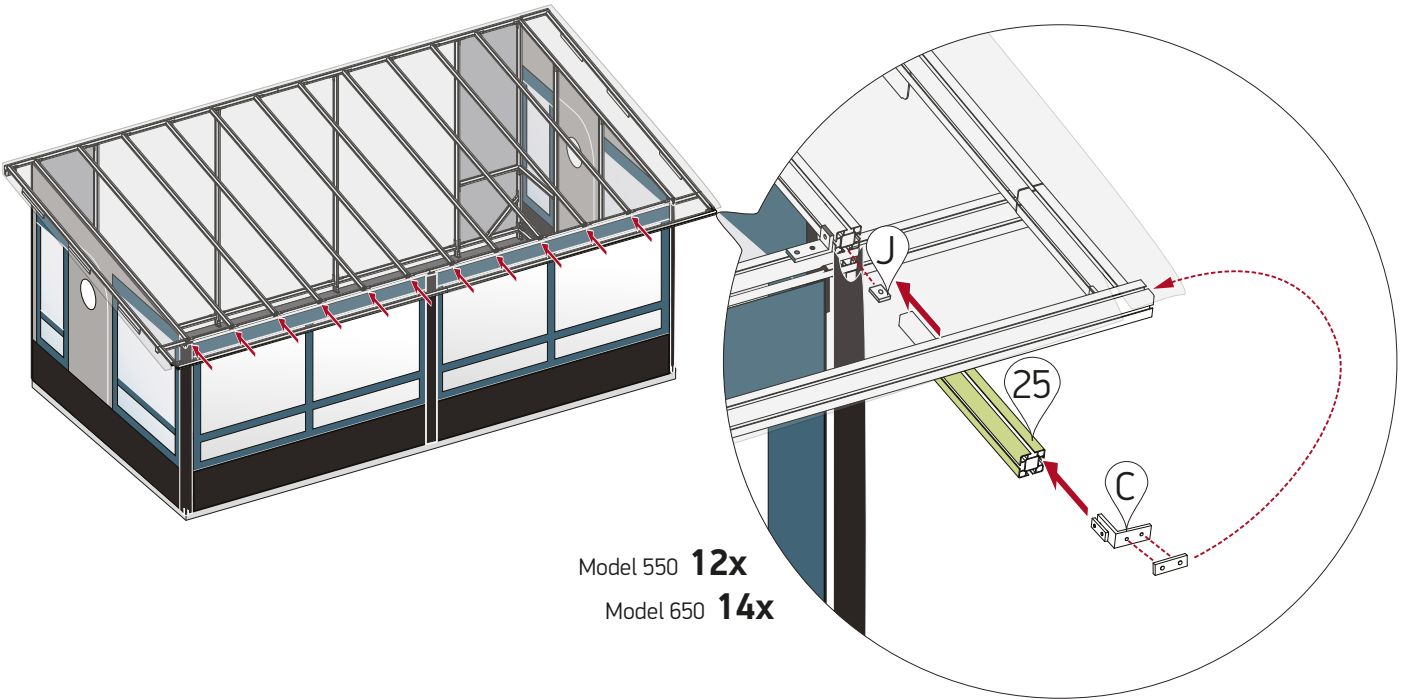

Model 550 **12x**
Model 650 **14x**

41

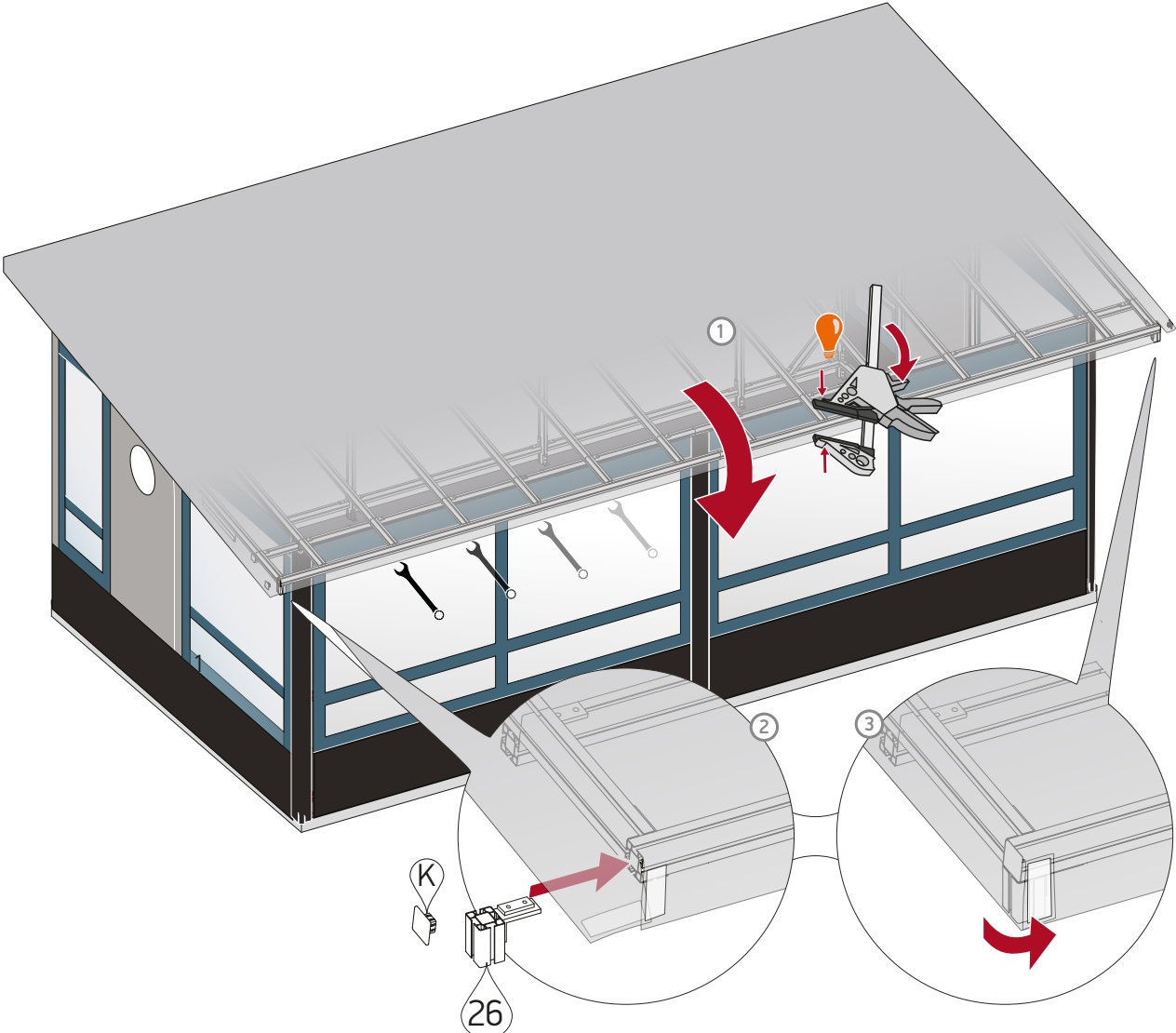

42

14 x 



Model 650 16 x 

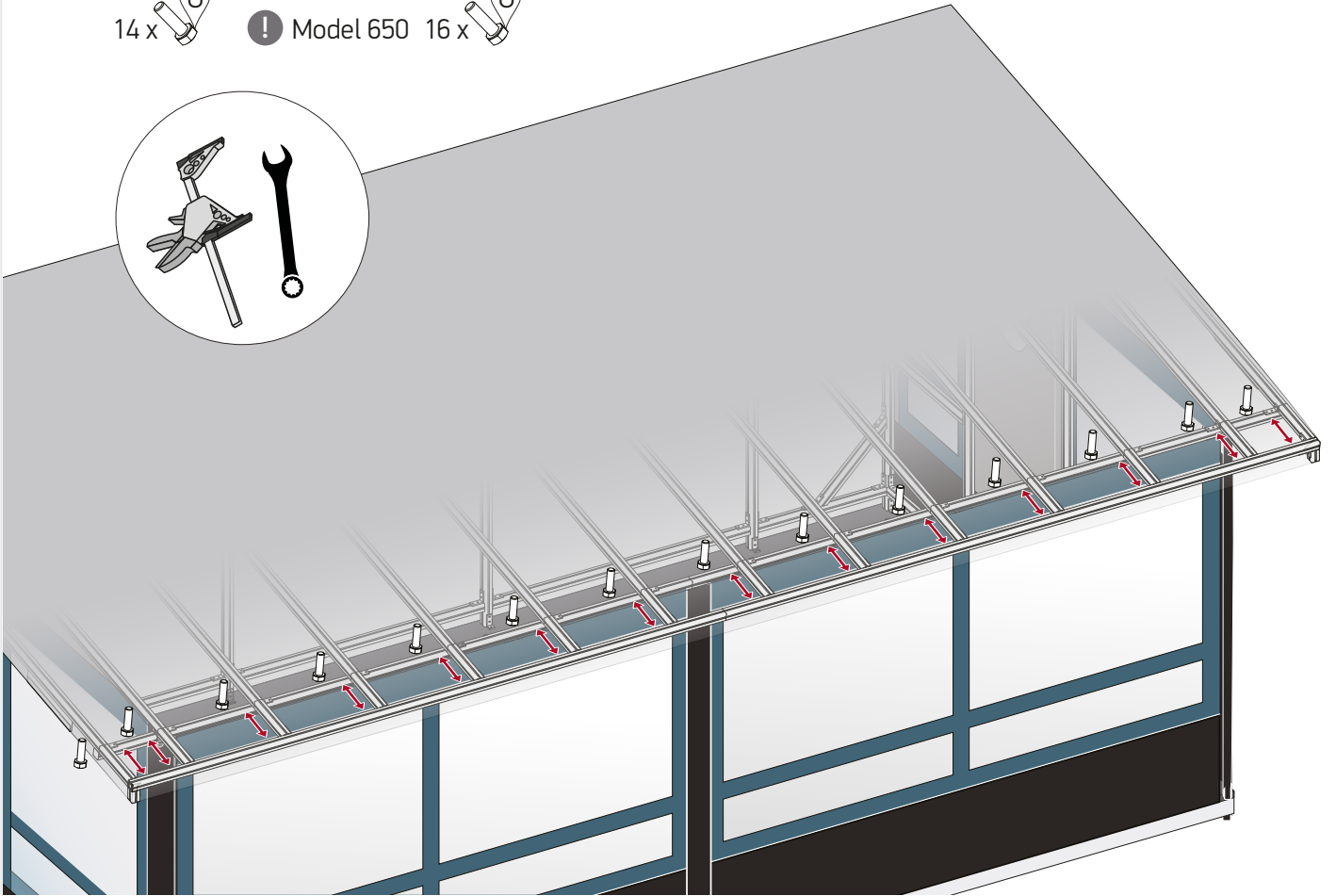

43

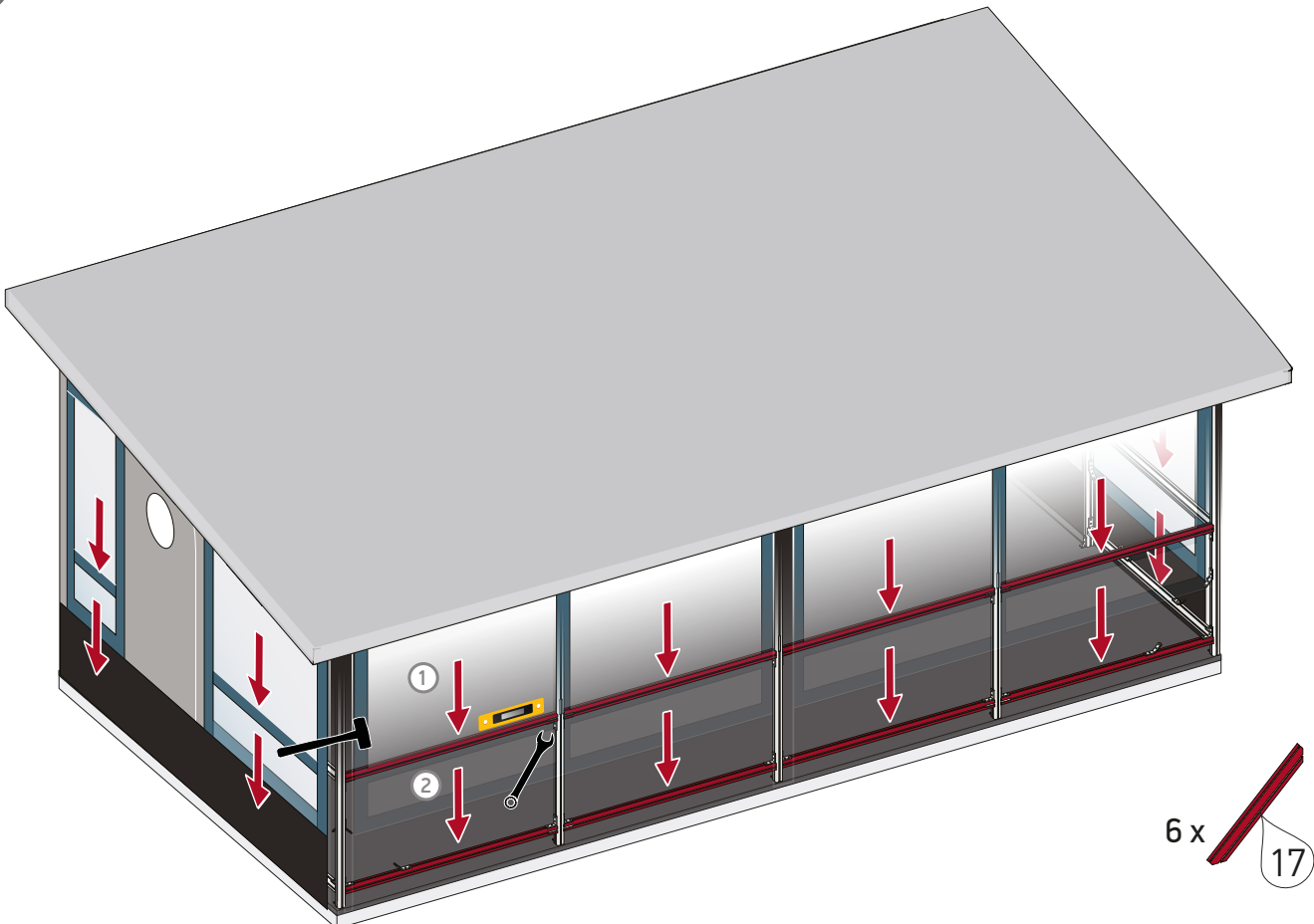

6 x

17

44

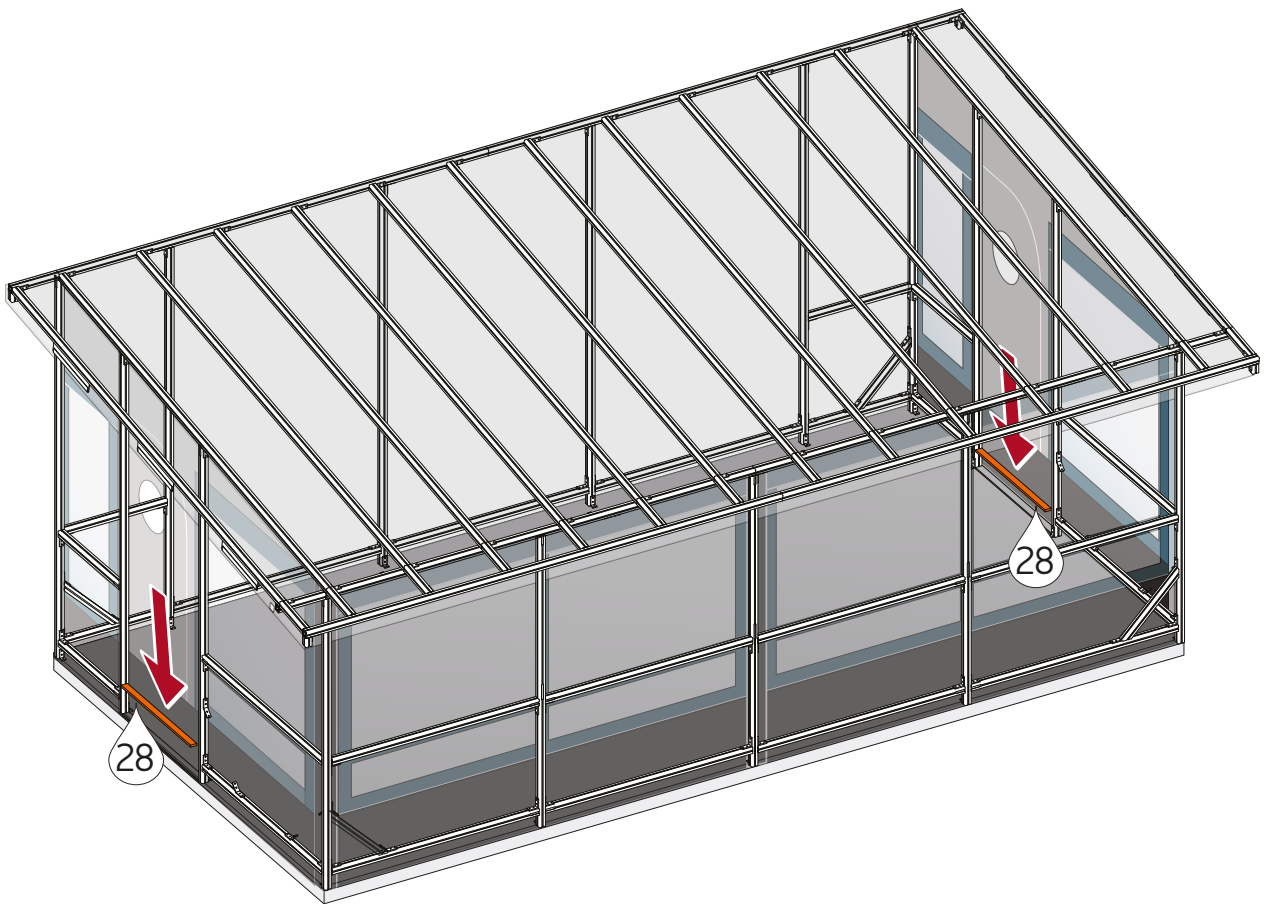

45

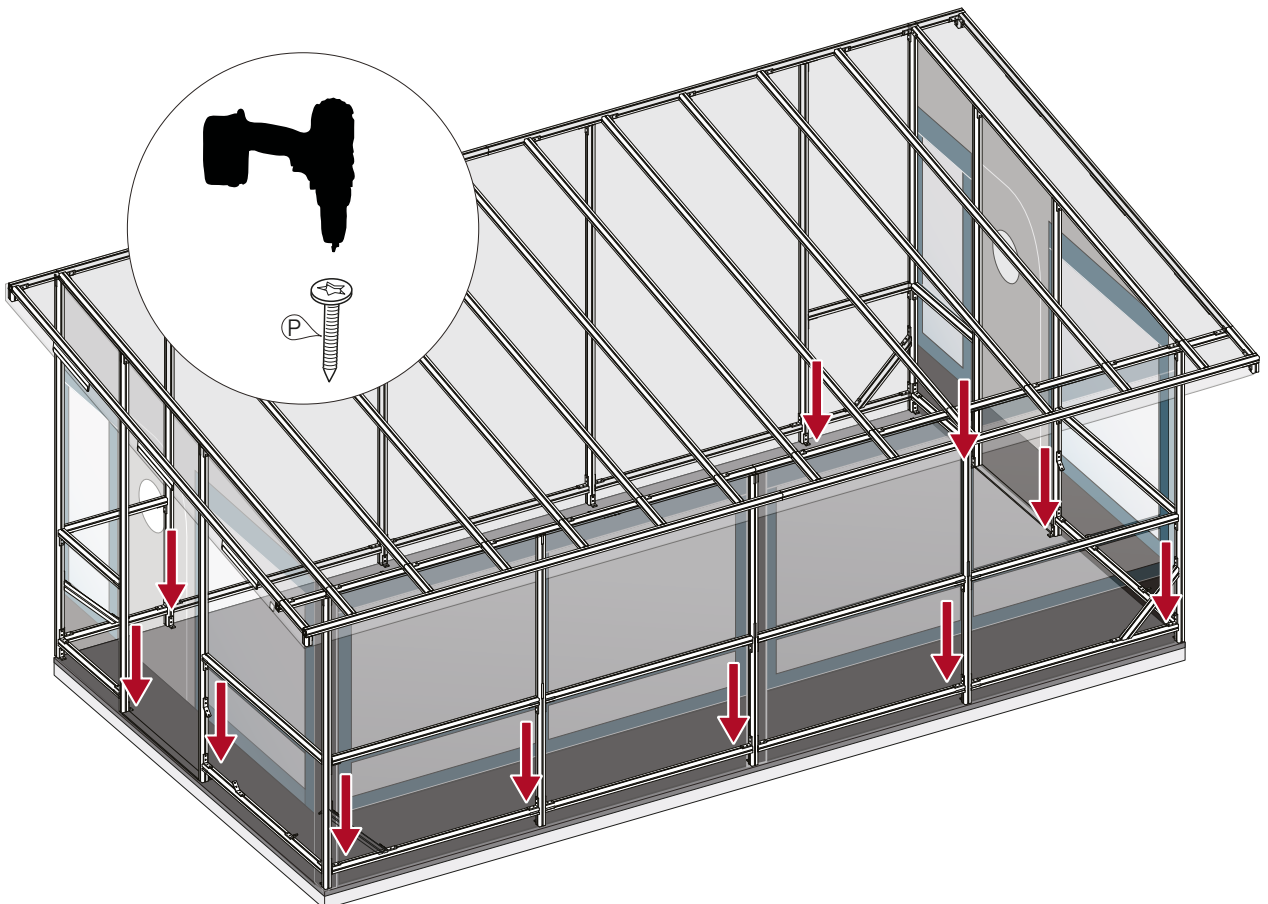

- ① Afstanden mellem fortelt og caravan skal være 8-10 cm
Avstanden mellom fortelt og campingvogn bør være 8-10 cm
The distance between the awning and the caravan must be 8-10 cm.
- ② Træk slusen i campingvognens skinne
Trek slusen i campingvognens skinne
Pull the connection piece into the rail on the caravan
- ③ Hold vulsten fra slusen hen til bagvæggens vulst og forbind begge med dobbelprofilskinner.
Hold vulsten fra slusene til bakveggens vulst og koble både med dobbelprofilskinner.
Join the beading from the connection piece and the beading on the back wall with double channels.
- ④ Skulle vulsten fra slusen ikke nå vulsten fra bagveggen på grund af campingvognens form (aerodynamik), kan man med en hobbykniv forsigtigt skære ind i vulsten ved campingvognen indtil den kan nå bagveggen og fastgøres hertil. Det løsthængende stof skæres skråt af ned mod hjørnet af teltet. Afkort dobbelprofilskinne tilsvarende.

Skulle perle fra låsen ikke når perle fra bakveggen på grunn av campingvogn form (aerodynamikk), kan du med et verktøy kniv nøye kuttet i perlen på campingvogn til du kommer bak veggen og festet til dette. Den løse stoff kuttet på skrå nedover mot hjørne av teltet. Forkorte dobbelprofilskinne deretter.

It is possible to carefully cut the beading along the caravan if the beading on the connection piece and the beading on the back wall does not come together because of the shape of the caravan. The fabric hanging loose is cut diagonally towards the corner of the awning. Shorten the double channels correspondingly.

Vær opmærksom på at slusen tjener som tagrende. I begge sider må vand derfor kunne løbe af.

Vær oppmerksom på at slusen fungerer som en takrenne. Begge sider må derfor vannet kunne renne av.

Be aware that the connection piece serves as gutter. Water must be able to run of in both sides.

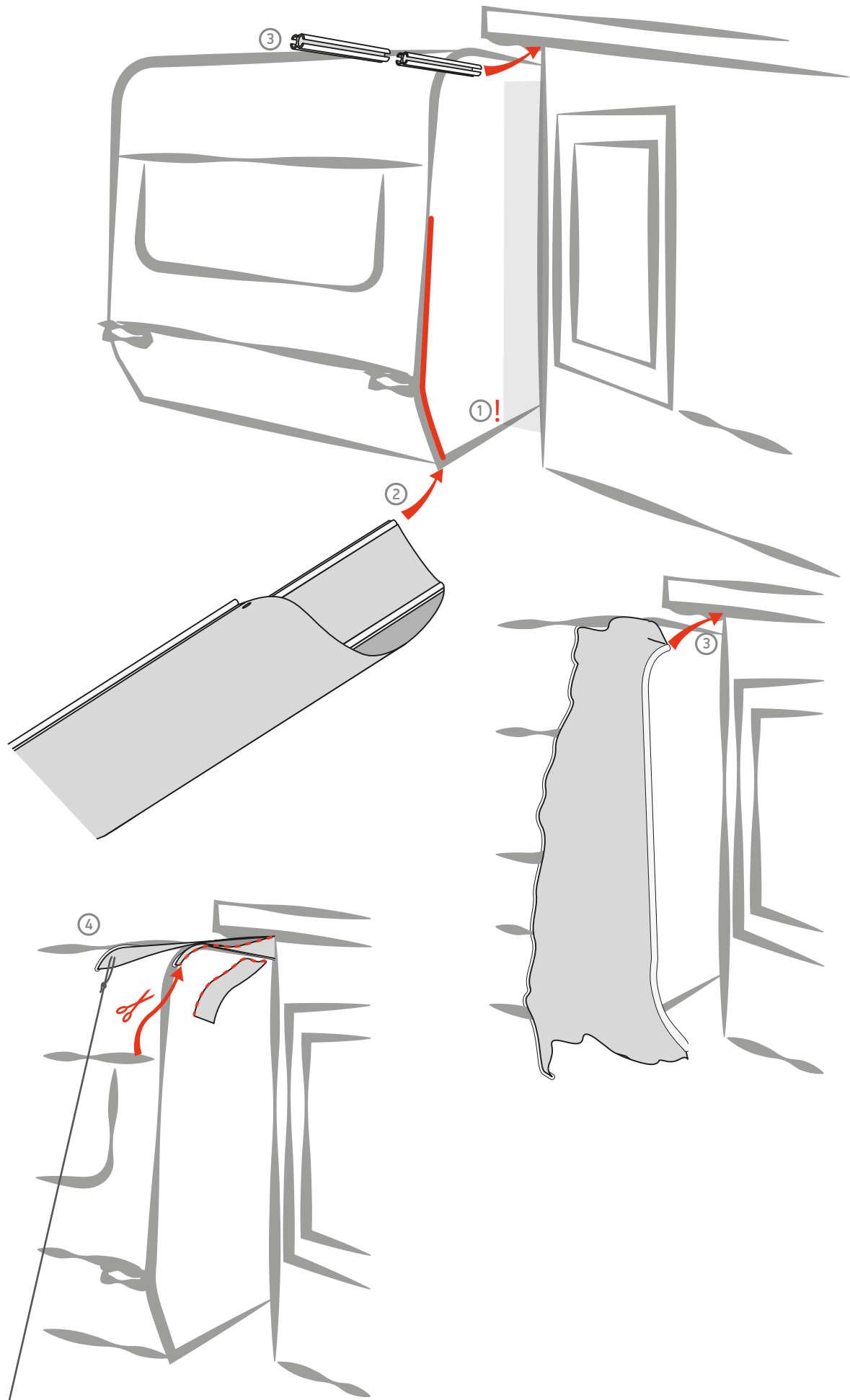

www.isabella.net

